



Wellcraft®

210 Coastal

OWNER'S MANUAL



Wellcraft Marine Corp.
1651 Whitfield Ave.
Sarasota, FL 34243

WELCOME ABOARD

Congratulations on your new boat purchase and welcome to the Wellcraft boating family!

We want your boating experience to be the most enjoyable possible. The more you know about your new boat, the more you'll enjoy the time you spend aboard. That's why we prepared this manual. It's your guide for safe operation as well as understanding your boat's systems and equipment. It has been written for the beginning boater but experienced boaters will find helpful information as well. Be sure to read the contents thoroughly.

The popularity of boating and other water sports has grown tremendously in the past few years. Because of this, safety is an important issue for everyone who shares our waterways. Remember that along with the freedom and exhilaration of boating comes the responsibility that you have for the safety of your passengers and the other boaters who share the water with you. Throughout this manual, specific precautions and symbols identify safety-related information. These symbols and associated instructions are in the form of Danger, Warning and Caution statements. They are described in the Safety Information section of the manual. Be sure to pay close attention to them.

The precautions in this manual can't and don't cover every boating situation. If a specific method or procedure is not recommended, you must make sure that what you do is safe for you and others. Always use common sense when boating! Remember too that every safe boating excursion is a happy experience.

This manual has been compiled to help you operate your craft with safety and pleasure. It contains the details of the craft, the equipment supplied or fitted, its systems, and information on its operation and maintenance. Please read it carefully and familiarize yourself with the craft before using it. If this is your first craft, or if you are changing to a type of craft you are not familiar with, for your own comfort and safety, please ensure that you obtain handling and operating experience before "assuming command" of the craft. Your dealer or national sailing federation or yacht club will be pleased to advise you of local sea schools and competent instructors.

We'd also like to remind you to be kind to our environment while you're boating. Don't throw garbage and other refuse overboard. And do your best to keep harmful compounds like gasoline, diesel fuel and antifreeze out of the water.

SAFETY INFORMATION

Your Wellcraft manual has been written to include a number of safety instructions to assure the safe operation and maintenance of your boat. These instructions are in the form of **DANGER, WARNING, and CAUTION** statements. The following definitions apply:

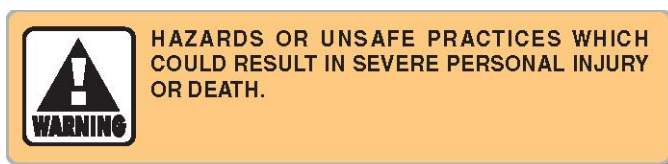
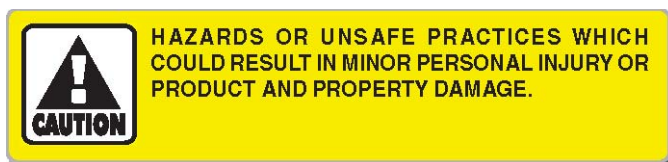

All instructions given in this book are as seen from the stern looking toward the bow, with starboard being to your right, and port to your left. A glossary of boating terms is included.

IMPORTANT NOTE: Your boat uses internal combustion engines and flammable fuel. Every precaution has been taken by Wellcraft to reduce the risks associated with possible injury and damage from fire or explosion, but your own precaution and good maintenance procedures are necessary in order to enjoy safe operation of your boat.



A WIDE VARIETY OF COMPONENTS USED ON THIS VESSEL CONTAIN OR EMIT CHEMICALS KNOWN TO THE STATE OF CALIFORNIA TO CAUSE CANCER AND BIRTH DEFECTS AND OTHER REPRODUCTIVE HARM.

EXAMPLES INCLUDE:

- ENGINE AND GENERATOR EXHAUST.
- ENGINE AND GENERATOR FUEL, AND OTHER LIQUIDS SUCH AS COOLANTS AND OIL, ESPECIALLY USED MOTOR OIL.
- COOKING FUELS.
- CLEANERS, PAINTS, AND SUBSTANCES USED FOR VESSEL REPAIR.
- WASTE MATERIALS THAT RESULT FROM WEAR OF VESSEL COMPONENTS.
- LEAD FROM BATTERY TERMINALS AND FROM OTHER SOURCES SUCH AS BALLAST OR FISHING SINKERS.

TO AVOID HARM:

- KEEP AWAY FROM ENGINE, GENERATOR, AND COOKING FUEL EXHAUST FUMES.
- WASH AREAS THOROUGHLY WITH SOAP AND WATER AFTER HANDLING THE SUBSTANCES ABOVE.

California Health & Safety Code §§ 25249.5-.13

BOAT INFORMATION

Please fill out the following information section that pertains to your model and leave it in your Wellcraft owner's manual. This information will be important for you and Wellcraft service personnel to know, if you may need to call them for technical assistance or service.

BOAT			
MODEL:		HULL SERIAL #:	
PURCHASE DATE:		DELIVERY DATE:	
IGNITION KEYS #:		REGISTRATION #:	
WEIGHT:	DRAFT:	BEAM:	VERTICAL CLEARANCE:
DOOR KEYS #:			
ENGINES			
MAKE:		MODEL:	
PORT SERIAL #:		STARBOARD SERIAL #:	
TRANSMISSIONS			
MAKE:		MODEL:	
PORT SERIAL #:		STARBOARD SERIAL #:	
RATIO:			
GENERATOR			
MAKE:		MODEL:	
SERIAL #:		KILOWATTS:	
PROPELLERS			
MAKE:		BLADES:	
DIAMETER/PITCH:		SHAFT:	
AIR CONDITIONER			
MAKE:		MODEL:	
SERIAL #:		BTU OUTPUT:	
DEALER		WELLCRAFT	
NAME:		PHONE:	
DEALER/PHONE:		REPRESENTATIVE:	
SALESMAN:		ADDRESS:	
SERVICE MANAGER:			
ADDRESS:			
DEALER E-MAIL:		WELLCRAFT E-MAIL:	

Wellcraft reserves the right to make changes and improvements in equipment, design and vendor equipment items, at any time without notification.

210 COASTAL SPECIFICATIONS

L.O.A.	21' (6.4 m)
Beam	8' 6" (2.59 m)
Dry weight (approx.)*	3575 lbs. (1621.6 kg)
Fuel capacity (Gas)	101 gal. (382.33 L)
Water Capacity (option)	5 gal. (18.93 L)
Max power @ prop	250 HP (186 kw)
Transom height	25" (.64 m)
Dead rise	19°
Draft: engine up (approx.)	17" (.43 m)
Draft: engine down (approx.)	33" (.84 m)
Bridge clearance w/bimini top (approx.)	7' (2.13 m)
Bridge clearance w/hardtop (optional) (approx.)	7'11" (2.41 m)

* Dry weight calculated does not include engine(s). Dry weight will vary with engine and options installed.

CERTIFICATIONS & SPECIFICATIONS

(For Export Only)

To be in compliance with European directives for recreational boats as published by the International Organization for Standardization (ISO) in effect at the time this boat was manufactured, we are providing the following information.

Manufacturer:

Name _____

Address _____

_____ Zip Code: _____

Identification Numbers:

Hull Identification Number _____

Port Engine Serial Number _____

Starboard Engine Serial Number _____

Intended Design Category:

Ocean

Inshore

Offshore

Sheltered Waters

Weight and Maximum Capacities:

Unladen Weight - Kilograms (Pounds) _____

Maximum Load - Weight- Kilograms (Pounds) _____

Number of People _____

Maximum Rated Engine Horsepower - Kilowatts (Horsepower) _____

Certifications:

Certifications & Components Covered _____

IMPORTANT INFORMATION

Owner's Manual

Spend some time looking through this manual. It contains information concerning the operation and care of your boat. The descriptions contained within the manual will introduce you to the features of the boat and provide you with a general knowledge of how the equipment works. The manual is divided into sections that are listed in the Table of Contents.

All instructions given in this book are as seen from the stern looking toward the bow with starboard being to your right, and port to your left. The information and precautions listed in this manual are not all inclusive. It may be general in nature in some cases and detailed in others. The suppliers of some of the major components such as engines, pumps, and appliances, provide their own owner's manuals which have been included with your boat. You should read the information in this manual and the manuals of other suppliers completely and have a thorough understanding of all component systems and their proper operation before operating your boat.

REMEMBER - IT IS YOUR RESPONSIBILITY TO ENSURE THAT YOUR BOAT IS SAFE FOR YOU AND YOUR PASSENGERS. ALWAYS EXERCISE GOOD COMMON SENSE WHEN INSTALLING EQUIPMENT AND OPERATING THE BOAT.

Warranty and Warranty Registration Cards

The Wellcraft Limited Warranty Statement is printed in this manual and on the warranty registration card. It has been written to be clearly stated and easily understood. If you have any questions after reading the warranty, please contact your dealer or the Wellcraft Customer Service Department.

Wellcraft Marine Corp.
Attn: Customer Service
1651 Whitfield Avenue
Sarasota, FL 34243
Phone: (941) 753-7811

Wellcraft, engine manufacturers, and the suppliers of major components maintain their own manufacturer's warranty and service facilities. ***It is important that you properly complete the warranty registration cards included with your boat and engine(s) and mail them back to the manufacturer to register your ownership.*** This should be done within 15 days of the date of purchase and before the boat is put into service. A form for recording this information for your records is provided at the beginning of this manual. This information will be important for you and service personnel to know, if and when you may need service or technical information.

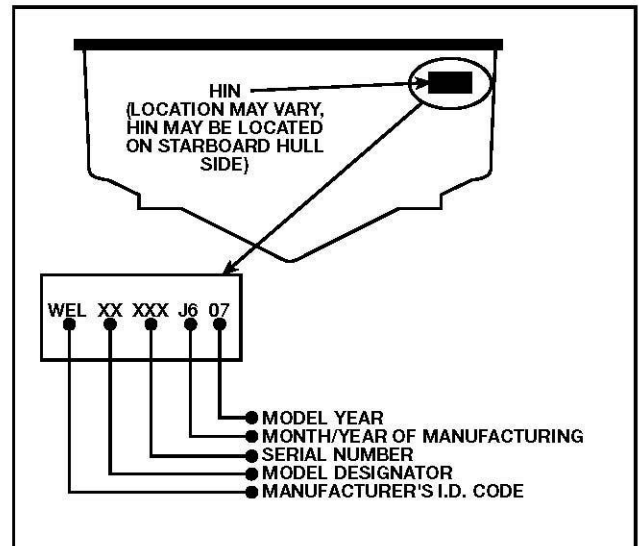

Hull Identification Number Location

The boat warranty registration requires the Hull Identification Number "HIN" which is located on the starboard side of the transom, just below the rubrail. The engine warranty registration requires the engine serial numbers. Please refer to the engine owner's manual for the location of the serial numbers.

Note: There are items which are not covered by this warranty. These items are outlined in the warranty statement.

By signing the warranty registration card you, the new owner, indicate an understanding of the terms and conditions of the limited warranty. The warranty registration card should be properly completed by the dealer, signed by the new owner, and returned to us within fifteen (15) days after the original purchase in order to validate the warranty. Be sure to keep the Owner's Registration Card for your records.

IMPORTANT:

All boat manufacturers are required by the Federal Boat Safety Act of 1971 to notify first time owners in the event any defect is discovered "which creates a substantial risk of personal injury to the public." ***It is essential that we have your warranty registration card complete with your name and mailing address in our files so that we can comply with the law if it should become necessary.***

Transferring the Warranty

All rights and terms of the Limited Warranty can be transferred to subsequent owners of Wellcraft models for the duration of the original warranty period. To take advantage of this program, you must complete a **Warranty Registration Transfer Form** found in this chapter and send it to Wellcraft Marine Corp., Attention

Customer Service Department, 1651 Whitfield Ave., Sarasota, FL 34243, within 15 days of the date of resale. The transfer request must be accompanied by a copy of the title/registration and the transfer fee as determined by the boat length overall:

Boat Length Overall	Transfer Fee
Up to 21'	\$200.00
Over 21'	\$300.00
Over 26'	\$500.00

Wellcraft will confirm, in writing, that the transfer of the warranty has taken place. After which, the transferee will be treated as the original purchaser as outlined in the Wellcraft Limited Warranty Statement.

Warranty Service

As the owner, you are responsible for the proper registration of your boat at the time of purchase. You must also follow proper operation procedures and adhere to the care and maintenance procedures set forth in this manual. Be sure to read your boat's warranty, as well as the information and warranties (provided in your owner's portfolio) for major components. You are responsible for notifying your dealer in writing of any claimed defect within a reasonable period of time and returning your boat to your dealer for service.

All warranty repairs must be performed by an authorized Wellcraft dealer. Your dealer has been carefully selected to assist you with your sales and service needs. Your dealer will be glad to answer any of your questions about your new boat. The dealer has a direct interest in you as a customer and wants to see that you are completely satisfied with your purchase. The dealer is in the best position to help you and has full support and assistance from Wellcraft Marine.

Should a problem develop that is related to faulty workmanship or materials, as stated in the Limited Warranty, you should contact your Wellcraft dealer to arrange for the necessary repair. If you are not near your dealer or another authorized Wellcraft dealer or the dealer fails to remedy the cause of the problem, then contact Wellcraft Customer Service by calling (941) 753-7811 or by writing.

Wellcraft Marine Corp.
Customer Service Department
1651 Whitfield Avenue
Sarasota, FL 34243

Have the following information available:

- HIN (hull identification number)
- Selling dealer's name and location
- Date of purchase
- Servicing dealer (if different from selling dealer)
- Nature of problem

- Names of dealership personnel involved with the situation
- Record of service performed and approximate dates.

When contacting Wellcraft Marine, keep in mind that your problem will most likely be resolved at the dealership, using the dealership's facilities, equipment, and personnel.

It is the boat owner's responsibility to deliver the boat to the dealer for warranty service.

Construction Standards:

All our boats meet or exceed the construction standards set by the U.S. Coast Guard and the American Boat and Yacht Council (ABYC) concerning:

- Navigational lights
- Factory installed fuel systems
- Engine and fuel tank compartment ventilation
- Flootation
- Steering systems
- Backfire flame arresters

We recommend that you see your dealer if you wish to modify factory-installed equipment or add new equipment. Your dealer is qualified to make such modifications or additions without placing the safety or design integrity of your boat at risk and without invalidating the warranty.

Dealer Responsibilities:

Your dealer will complete the pre-delivery checklist with you when you take delivery of your boat. A copy of the checklist is at the end of this section. Your dealer will also provide the following services:

- Take time to sit with you and review the terms and the process for registering all warranties. The dealer should also brief you on obtaining warranty service for the boat and major components and introduce you to the Service Manager.
- Review the pre-delivery service record with you. The service record form must be signed by you and the dealer to certify that the work was performed to your satisfaction and that your boat is in top-notch condition and that all components are working properly.
- Sea trial the boat with you and provide a thorough orientation on the operation of the boat and its systems. If requested, provide you with comprehensive instruction in the operation of your boat and all its installed systems and components.

Boat Owner Responsibilities:

- Sit down with your dealer and review the terms of all warranties. Complete the Wellcraft, engine and major component warranty registration cards and mail them to the manufacturers.
- Fill out the boat information form located in this manual.
- Inspect the boat at the time of delivery and review the pre-delivery service record form with your dealer. The record should be signed by you when the orientation is complete and you are satisfied with the operation of all systems.
- Read the boat and equipment owner's manuals and operate the boat and all equipment as instructed.
- Read and follow the engine manufacturer's instructions for initial inspection, break in, and service.
- Schedule the 20 hour service and make sure all periodic maintenance is performed as outlined in the boat, engine, and component owner's manuals.
- Know your boat and the rules of the road before you use your boat.

Important: Make sure that your dealer checks the engine alignment during your boat's commissioning and at the 20-hour checkup. The engine alignment check should be performed in accordance with the recommended procedures as stated by the engine manufacturer in your engine owner's manual. Failure to do so could result in drive train damage which is not covered under the warranty.

- We recommend that you reference your engine warranty certificate for initial inspection and service requirements.

Product Changes

Wellcraft is committed to the continuous improvement of our boats. As a result, some of the equipment described in this manual or pictured in the catalog may change or no longer be available. ***Wellcraft reserves the right to change standard equipment, optional equipment and specifications without notice or obligation.*** If you have questions about the equipment on your Wellcraft, please contact your dealer or the Wellcraft Customer Service Department.

Discharge of Oil

The Federal Water Pollution Control Act prohibits the discharge of oil or oily waste into or upon the navigable waters of the United States or the waters of the contiguous zone if such discharge causes a film or sheen

upon or a discoloration of the surface of the water or causes a sludge of emulsion beneath the surface of the water. Violators are subject to a penalty of \$5,000.00.

Disposal of Plastics & Other Garbage

Plastic refuse dumped in the water can kill fish and marine wildlife and can foul boat propellers and cooling water intakes. Other forms of waterborne garbage can litter our beaches and make people sick. U.S. Coast Guard regulations prohibit the dumping of plastic refuse or other garbage mixed with plastic into the water anywhere, and restrict the dumping of other forms of garbage within specified distances from shore.

Marpol Treaty

Boats 26 feet or longer must display a sign stating the disposal regulation of the Federal Water Pollution Control Act. The U.S. Coast Guard has issued these regulations to implement Annex V of the International Convention for the Prevention of Pollution from Ships, 1973, commonly known as Annex V of the Marpol (Marine Pollution) Treaty 73/78. They apply to all U.S. boats wherever they operate (except waters under the exclusive jurisdiction of a State) and foreign boats operating in U.S. waters out to and including the Exclusive Economic Zone (200 Miles.) It is important to know these regulations and adhere to them.

The regulations require U.S. recreational boaters, if your boat is 26 feet or more in length, to affix one or more USCG Trash Dumping Restrictions placards to your boat. The placard warns against the discharge of plastic and other forms of garbage within the navigable waters of the United States and specify discharge restrictions beyond the territorial sea. (The territorial sea generally ends three nautical miles from the seashore.) In addition, the placard must contain the warning that a person who violates these requirements is liable to civil (\$25,000) and criminal (imprisonment) penalties. The placard also must note that State and local regulations may further restrict the disposal of garbage.

Operators shall display one or more placards in a prominent location and in sufficient numbers so they can be observed and read by crew and passengers. These locations might include embarkation points, food service areas, galleys, garbage handling spaces and common deck spaces frequented by crew and passengers. We recommend that these placards be installed on all boats. The placards may be purchased from local marinas, boat dealerships and marine equipment suppliers. A special placard is available for boats operating on the Great Lakes.

Important: It is illegal to discharge waste from your marine sanitary device (toilet) into the water in most areas. It is your responsibility to be aware of and adhere to all local laws concerning waste discharge. Consult with the Coast Guard, local marina or your dealer for additional information.

Note: Some states and localities have legal limits on speed, noise and trailer specifications. It is your responsibility to be aware of these laws and limits and to insure that your boat complies. Consult with your local Marine Patrol or local Coast Guard office.

Registration and Numbering

Federal law requires that all undocumented vessels equipped with propulsion machinery be registered in the State of principal use. A certificate of number will be issued upon registering the boat. These numbers must be displayed on your boat. The owner/operator of a boat must carry a valid certificate of number whenever the boat is in use. When moved to a new State of principal use, the certificate is valid for 60 days.

In order to be valid, the numbers must be installed to the proper specifications. Check with your dealer or state boating authority for numbering requirements. The Coast Guard issues the certificate of number in Alaska; all others are issued by the state.

Insurance

In most States the boat owner is legally responsible for damages or injuries he or someone else operating the boat causes. Responsible boaters carry adequate liability and property damage insurance for their boat. You should also protect the boat against physical damage and theft. Some States have laws requiring minimum insurance coverage. Contact your dealer or State boating authority for information on the insurance requirements in your boating area.

Reporting Boating accidents

All boating accidents must be reported by the operator or owner of the boat to the proper marine law enforcement authority for the state in which the accident occurred. Immediate notification is required if a person dies or disappears as a result of a recreational boating accident.

If a person dies or there are injuries requiring more than first aid, a formal report must be filed within 48 hours.

A formal report must be made within 10 days for accidents involving more than \$500.00 damage or the complete loss of a boat. The 1994 Recreational Boating Act may impose a \$1,000.00 civil fine for people who fail to submit a boating accident report.

A Boating Accident Report form is located near the back of this manual to assist you in reporting an accident. If you need additional information regarding accident reporting, please call the Boating Safety Hotline, 800-368-5647. If you see a distress signal, you must assume it is a real emergency and render assistance immediately. The master or person in charge of a boat is

obligated by law to provide assistance to any individual in danger at sea. However, you should not put your boat or crew in a dangerous situation which exceeds your capabilities or those of your boat. The 1971 Boating Safety Act grants protection to a Good Samaritan boater offering good faith assistance, and absolves a boater from any civil liability arising from assistance given.

Required Equipment

U.S. Coast Guard regulations require certain equipment on each boat. The Coast Guard also sets minimum safety standards for vessels and associated equipment. To meet these standards some of the equipment must be Coast Guard approved. "Coast Guard Approved Equipment" has been determined to be in compliance with USCG specifications and regulations relating to performance, construction, or materials. The equipment requirements vary according to the length, type of boat, and the propulsion system. Some of the Coast Guard equipment is described in the Safety Equipment chapter of this manual. For a more detailed description, obtain "Federal Requirements And Safety Tips For Recreational Boats" by contacting the Boating Safety Hotline 800-368- 5647, the Coast Guard Office of Boating Safety at www.uscgboating.org or your local marine dealer or retailer.

Some state and local agencies impose similar equipment requirements on waters that do not fall under Coast Guard jurisdiction. These agencies may also require additional equipment that is not required by the Coast Guard. Your dealer or local boating authority can provide you with additional information for the equipment requirements for your boating area.

Briefing Passengers

Before each outing, ensure that at least one passenger is familiar with the proper operation and safety aspects of the boat in case of emergency. Show all passengers the location of safety equipment.

Courtesy On-The-Water

- Know the rules of the water and practice them at all times.
- Be familiar with traffic patterns of the body of water on which you are boating.
- Give fishermen, sailboats (not under power), and water skiers plenty of room.
- You are responsible for spotting and avoiding swimmers and slow-moving vessels.
- You are also responsible for damage caused by your wake.
- Operate at slow speeds in restricted and congested areas.
- Keep a lookout for personal watercraft. They have the same rights and responsibilities as you do.

- Contact your local or state boating authorities for information on boating and safety courses.
- Keep boating safe and fun for everyone!

Education

If you are not an experienced boater, we recommend that the boat operator and other people that normally accompanies the operator, enroll in a boating safety course. Organizations such as the U.S. Power Squadron, United States Coast Guard Auxiliary, State Boating Authorities and the American Red Cross offer excellent boating educational programs. These courses are worthwhile even for experienced boaters to sharpen your skills or bring you up to date on current rules and regulations. They can also help in providing local navigational information when moving to a new boating area. Contact your dealer, State Boating Authority or the Boating Safety Hotline, 800-368-5647 for further information on boating safety courses.

Contacts

American Red Cross (For local address consult the telephone directory)

Boat U.S. Foundation for Boating Safety Hotline
800-336-BOAT
800-245-BOAT (in Virginia)

Coast Guard Boating Safety Hotline and Office of Boating Safety
800-368-5647
www.uscgboating.org

Skippers Course
GPO Superintendent of documents
Washington, DC 20012

United States Coast Guard Auxiliary
Local Flotilla or contact appropriate Coast Guard District Headquarters
United States Coast Guard Headquarters
202-512-1800
202-512-2250 (fax)

United States Power Squadron
P.O. Box 30423
Raleigh, NC 27617

Recommended Reading

Damford, Don. Anchoring
(ISBN 0-915160-64-1) Seven Seas

United States Coast Guard Auxiliary. Boating Skills and Seamanship. LC74-164688. (illus.)
(ISBN 0-930028-00-7) U.S. Coast Guard.

Bottomley, Tom. Boatman's Handbook, (Illus.) 316 p. pap. (ISBN 0-688-03925-1, Hearst Marine BK.) Morrow.

Whiting, John and Bottomley, Tom. Chapman's Log and Owner's Manual. 192 p. (ISBN 0-87851-801-0); (ISBN 0-686-96737-2) Hearst Bks. Strahm, Virgil. Does Your Fiberglass Boat Need Repair? LC81-90093. 46 P. PAP (ISBN 0-9606050-0-2) Strahm.

Chapman, Charles F, and Maloney. E.S. Chapman's Piloting, Seamanship and Small Boat Handling. (illus.) 62 p. (ISBN 0-87851-814-2, Pub. by Hearst Bks); deluxe ed. (ISBN 0- 87851-815-0) Morrow

National Fire Protection Association, Fire Protection Standard for Pleasure and Commercial Motor Craft. (ISBN 0-317- 07388-5, NFPA 302) Natl. Fire Prot. Brotherton, Miner. Twelve/Volt Bible. Plastic comb. (ISBN 0-915160-81-1) Seven Seas.

Warranty Registration Transfer Request

Original Owner Name & Address: _____

Original Date of Purchase: _____

Hull Identification Number: _____

Boat Model: _____

Selling Dealer: _____

Name & address of second purchaser: _____

Telephone Number: _____

Date of Purchase: _____

2003 Model year and newer transfer fees:

16' - 21' boats \$200.00

22' - 26' boats \$300.00

27' - and up boats \$500.00

The remainder term of the Wellcraft warranty may be transferred to a new owner upon written request. The transfer must occur within five (5) years of the original retail sale. The warranty may only be transferred **once**. Written inspection by a current Wellcraft dealer or an authorized Wellcraft representative must accompany Warranty Transfer Application form below. The Warranty Transfer Application must be received by Wellcraft within 15 days of purchase by the Second Retail Purchaser. Please complete the application, and return with payment made payable to Wellcraft to the address shown below. **The request must be accompanied by copy of the title/registration, warranty registration transfer request form completed in its entirety.**

This warranty registration request, if accepted, transfers the warranty coverage remaining on the boat to the second purchaser. Acceptance of the request does not create any additional warranties or obligation on Wellcraft.

To be completed by Dealer or Authorized Representative:

Boat Transfer Inspection Date: _____ Inspected By: _____

Condition: Exterior _____ Mechanical _____

Interior _____ Overall Condition _____

To be completed by Manufacturer:

Warranty Expiration Date: _____

Wellcraft Authorized Acceptance Date: _____

Wellcraft Authorized Signature: _____

Mail to: **Wellcraft**, 1651 Whitfield Ave., Sarasota, FL 34243, Attn: Customer Service



TABLE OF CONTENTS

Chapter 1

PROPULSION SYSTEM

1.1	General	18
1.2	Drive System Corrosion	18
1.3	Engine Lubrication	18
1.4	Engine Cooling System	19
1.5	Propellers	19
1.6	Performance Issues and Propellers	19
1.7	Engine Instrumentation	20

Chapter 2

HELM CONTROL SYSTEMS

2.1	General	22
2.2	Engine Controls	22
2.3	Neutral Safety Switch	22
2.4	Engine Power Tilt and Trim	22
2.5	Engine Stop Switch	23
2.6	Steering System	23
2.7	Control Systems Maintenance	23

Chapter 3

FUEL SYSTEM

3.1	General	24
3.2	Engine Fuel Supply System	24
3.3	Fueling Instructions	25
3.4	Fuel System Maintenance	25

Chapter 4

ELECTRICAL SYSTEMS

4.1	General	27
4.2	12-Volt System	27
4.3	12-Volt Accessory Switch Panel	28

Chapter 5

DRAINAGE SYSTEMS

5.1	General	29
5.2	Bilge Drainage	29
5.3	Drainage System Maintenance	29
5.4	Cabin Drains	29
5.5	Drainage System Maintenance	29

Chapter 6

VENTILATION SYSTEM

6.1	Cabin Ventilation	31
6.2	Carbon Monoxide and Proper Ventilation	31
6.3	Maintenance	32

Chapter 7

EXTERIOR EQUIPMENT

7.1	Deck	33
7.2	Hull	34
7.3	Cockpit	34

Chapter 8

INTERIOR EQUIPMENT

8.1	Self Contained Head	35
8.2	Cabin and V-Berth	35

Chapter 9

SAFETY EQUIPMENT

9.1	General	37
9.2	Required Safety Equipment	37
9.3	First Aid	38
9.4	Additional Safety Equipment	38
	Safety Labels	39

Chapter 10

OPERATION

10.1	General	40
10.2	Rules of the Road	40
10.3	Pre-Cruise Check	42
10.4	Operating Your Boat	43
10.5	Docking, Anchoring and Mooring	44
10.6	Controls, Steering or Propulsion System	46
	Failure	46
10.7	Collision	46
10.8	Grounding, Towing and Rendering	46
	Assistance	46
10.9	Flooding, or Capsizing	47
10.10	Fishing	47
10.11	Man Overboard	47
10.12	Trash Disposal	48
10.13	Trailer Your Boat	48

Chapter 11

ROUTINE MAINTENANCE

11.1 Exterior Hull and Deck	50
11.2 Upholstery, Canvas and Enclosure	52
11.3 Bilge and Engine Compartment	53
11.4 Engine and Fuel	53
11.5 Drainage System	54

Chapter 12

SEASONAL MAINTENANCE

12.1 Lay-Up and Storage	55
12.2 Winterizing	56
12.3 Recommissioning	58

Appendix A

Schematics	59
------------	----

Appendix B

Inspection / Service Checklist	69
Maintenance Log	72

Appendix C

Float Plan	74
------------	----

Appendix D

Boat Accident Report	75
----------------------	----

Appendix E

Glossary of Terms	77
-------------------	----

Appendix F

Troubleshooting Guide	82
-----------------------	----

Chapter 1:

PROPULSION SYSTEM

1.1 General

Your Wellcraft is designed to be powered with 2-cycle or 4-cycle outboard motors. Each manufacturer of the various outboard motors provides an owner's information manual with its product. It is important that you read the manual very carefully and become familiar with the proper care and operation of the engine and drive system. A warranty registration card has been furnished with each new engine and can be located in the engine owner's manual. All information requested on



DO NOT ATTEMPT TO SERVICE ANY ENGINE OR DRIVE COMPONENT WITHOUT BEING TOTALLY FAMILIAR WITH THE SAFE AND PROPER SERVICE PROCEDURES. CERTAIN MOVING PARTS ARE EXPOSED AND CAN BE DANGEROUS TO SOMEONE UNFAMILIAR WITH THE OPERATION AND FUNCTION OF THE EQUIPMENT.



DO NOT INHALE EXHAUST FUMES! EXHAUST CONTAINS CARBON MONOXIDE THAT IS COLORLESS AND ODORLESS. CARBON MONOXIDE IS A DANGEROUS GAS THAT IS POTENTIALLY LETHAL.

this card should be filled out completely by the dealer and purchaser and then returned to the respective engine manufacturer as soon as possible.

1.2 Drive System Corrosion

Each outboard motor is a complete drive system with the gear case being just forward of the propeller and connected to the power head with a vertical drive shaft. All engines require some maintenance. Routine maintenance recommended for your engine is outlined in the engine owner's manual. Routine maintenance is normally the primary concern unless the boat is to be kept in saltwater for extended periods of time. Then the main concerns are marine growth and galvanic corrosion.

Marine growth occurs when components are left in the water for extended periods and can cause poor performance or permanent damage to the exposed components. The type of growth and how quickly it occurs is relative to the water conditions in your boating area. Water temperature, pollution, current, etc. can have an effect on marine growth.

Galvanic corrosion is the corrosion process occurring when different metals are submerged in an electrolyte. Seawater is an electrolyte and submerged engine components must be properly protected.

Outboard motors are equipped with sacrificial anodes to prevent galvanic corrosion problems. The anodes must be monitored and replaced as necessary. For locations and maintenance, please refer to the engine owner's manual.

When leaving the boat in the water, tilt the motors as high as possible. This will decrease the risk of marine growth around the cooling inlets, propeller and exhaust ports and damage from galvanic corrosion.



DO NOT PAINT THE OUTBOARD MOTORS WITH ANTI-FOULING PAINTS DESIGNED FOR BOAT HULLS. MANY OF THESE PAINTS CAN CAUSE SEVERE DAMAGE TO THE ENGINES. CONTACT YOUR WELLCRAFT DEALER OR ENGINE MANUFACTURER FOR INFORMATION ON THE PROPER PAINTING PROCEDURES.

1.3 Engine Lubrication

2-cycle outboard motors are lubricated by a variable ratio oil injection system. The oil tanks are mounted in the stern bilge and accessed through a hatch in the cockpit sole. They are filled through fill fittings in the top of each tank. Each oil fill is opened by turning it counter clockwise. After filling tank, tighten the fill by turning it clockwise until it is snug.

Note: Do not over tighten the oil fill cap. If the cap is over tightened, it could be damaged allowing oil to leak out of the tank or water to contaminate the oil system.



SOME ENGINE MANUFACTURERS USE OIL TANKS THAT ARE UNDER PRESSURE WHEN THE ENGINES ARE OPERATING. IF THE ENGINE LUBRICATION SYSTEM FOR YOUR ENGINES IS PRESSURIZED, YOU MUST WAIT 5 MINUTES AFTER SHUT DOWN BEFORE OPENING THE OIL FILL CAP. YOU SHOULD REFER TO THE ENGINE OWNER'S MANUAL FOR SPECIFIC INFORMATION ON THE OIL SUPPLY SYSTEM AND REFILLING INSTRUCTIONS FOR YOUR ENGINE.

Always monitor the oil level in the remote tanks before each cruise by checking the gauge or indicator lights in the helm (not available on all engine installations) or visually checking the oil level using the reference marks on the tanks.

When additional oil is needed, use only the type of oil specified by the engine manufacturer. Refer to the engine owner's manual for oil specifications and additional information on the oil injection system.

Note: Always monitor the oil level in the tanks and only use the type of oil specified by the engine manufacturer.

4-cycle outboard engines have an oil sump in the crankcase that must be kept full of the type and grade of oil recommended by the engine manufacturer. It is normal for 4-cycle engines to consume a small amount of oil. Therefore, the oil must be checked before each use and changed at regular intervals as instructed by the engine owner's manual. As with 2-cycle engines, use only the type of oil specified by the engine manufacturer.

1.4 Engine Cooling System

Outboard engines are raw water (seawater) cooled. Water is pumped through the water inlets, circulated through the engine block, and relinquished with the exhaust gases through the propeller hub. The pump uses a small impeller made of synthetic rubber. The impeller and water pump cannot run dry for more than a few seconds. In most outboard motors, some cooling water is diverted through ports below the engine cowling. This allows the operator to visually check the operation of the cooling system. When the engine is started, always check for a steady stream of water coming out of those ports.

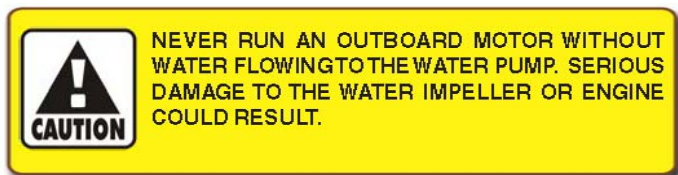

Note: If the boat is used in salt or badly polluted water, the engines should be flushed after each use. Refer to the engine owner's manual for the proper engine flushing procedure.

1.5 Propellers

The propellers convert the engine's power into thrust. They come in a variety of styles, diameters and pitches. The one that will best suit the needs of your Wellcraft will depend somewhat on your application and expected average load. Propeller sizes are identified by two numbers stamped on the prop in sequence. The 1st number in the sequence (example 14 x 21) is the diameter of the propeller, and the 2nd number is the pitch. Pitch is the theoretical forward distance traveled by the boat in each revolution of the propeller.

Always repair or replace a propeller immediately if it has been damaged. A damaged and therefore out of

balance propeller can cause vibration that can be felt in the boat and could damage the engine gear assembly. Refer to the engine owner's manual for information on propeller removal and installation.

1.6 Performance Issues and Propellers

It is extremely important that the boat is propped to run at or very near the recommended top RPM with an average load. If the top RPM is above or below the recommend range, the propellers must be changed to prevent loss of performance and possible engine damage.

Note: Before changing your propeller to correct boat performance problems, be sure other factors such as engine tuning, bottom and running gear growth, etc. are not the source of performance changes. Always be sure the load conditions are those normally experienced, before changing propeller.

Your boat was shipped with a prop that typically provide optimum performance for your boat. However there are factors that can affect performance and propeller requirements. Some are as follows:

- You should be sure the load conditions are those normally experienced. If the boat ran in the required RPM range when it was new and you have not added any additional gear or heavy equipment and have not damaged the propeller, there is a good chance the propeller is not the problem.
- The addition of heavy equipment like life rafts, additional coolers, etc., will cause additional load on the engine. Consequently, different propeller may be required.
- Outboard engines can be damaged and the warranty void if the boat is not propped correctly. Always consult your Wellcraft or authorized engine service dealer when making changes to the propellers or if the boat does not run near the top recommended RPM.
- Boats operated at high altitudes (above 2000 feet). Engines operated at high altitudes will not be able to develop as much horsepower as they do at or near sea level. Consequently, different propeller may be required.

1.7 Engine Instrumentation

The helm station is equipped with a set of engine instruments and/or alarms. These instruments allow the operator to monitor the engines' operational conditions. Close observation of these instruments allows the operator to operate the engine at the most efficient level and could save them from serious costly damage. The instrumentation is unique to the type of outboard motor installed on your boat. Some or all of the following gauges may be present.

Tachometer

The tachometer displays the speed of the engine in revolutions per minute (RPM). This speed is not the boat speed or necessarily the speed of the propeller. The tachometer may not register zero with the key in the "OFF" position.

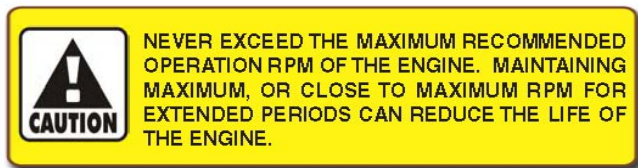

Speedometer

The speedometer indicates the speed of the boat in miles per hour. Most speedometers measure the water pressure against a small hole in a pickup located in the engine lower unit or mounted on the bottom of the transom.

Temperature Warning

The temperature warning indicates the temperature of the engine. A sudden increase in the temperature could indicate an obstructed water inlet or an impeller failure.

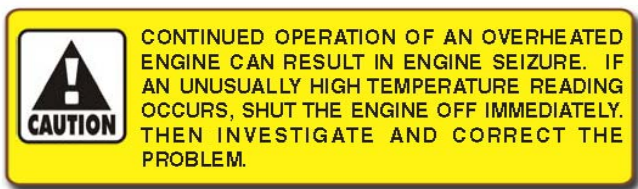

Water Pressure Gauge

The water pressure gauge indicates the pressure in the engine cooling system that is generated by the cooling pump. The water pressure indicated when the engine is new is usually the reference for normal water pressure for that engine. Refer to the engine manufacturer owner's manual for more information on the cooling system water pressure requirements for your engine.

A drop in water pressure is a possible indication of water pump problems or a blocked intake. Excessive pressure is a possible indication of an internal blockage. Unusually high or low water pressure should be investigated and corrected immediately.

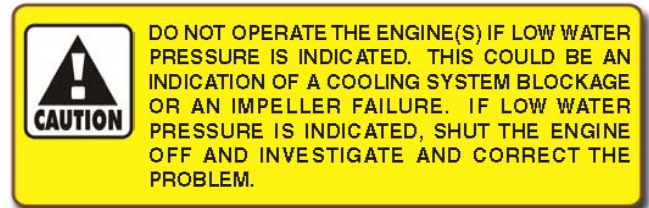

Oil Pressure Gauge

The oil pressure gauge monitors the engine lubrication system pressure on boats with 4-cycle engines. The oil pressure indicated when the engine is new is usually the reference for normal oil pressure for that engine. A drop in oil pressure is a possible indication of oil pump problems, a leak or fuel diluted oil.

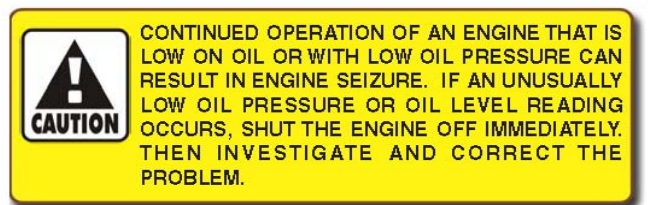

Fuel Gauges

The fuel gauge indicates the amount of fuel in the tank.

Refer to the engine or gauge manufacturer owner's manual for detailed information on the gauge installed in your boat.

Voltmeter

The volt meter displays the voltage for the battery and the charging system. The normal voltage is 11 to 12-volts with the engines off, and 13 to 14.5 volts with the engines running.

Engine Tilt/Trim Gauge

The tilt/trim gauge monitors the position of the outboard engine. The upper range of the gauge indicates the tilt, which is used for trailering and shallow water operation. The lower range indicates the trim position. This is the range used to adjust the hull angle while operating your boat on plane. Please refer the engine owner's manual for more information on the operation of the outboard power tilt and trim.

Engine Alarms

Most outboards are equipped with an audible alarm system mounted in the helm area that monitors selected critical engine systems. The alarm will sound if one of these systems begins to fail. Refer to the engine owner's manual for information on the alarms installed with your engine.

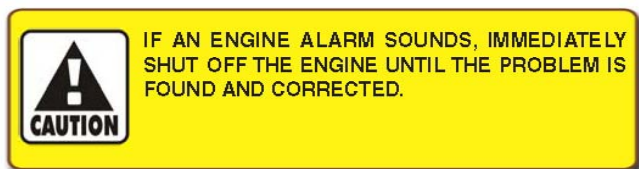

Fuel Management

Fuel management systems are standard equipment with some outboard engines. On Yamaha engines, the fuel management gauge is a multifunction gauge used to monitor the gallons per hour, miles per gallon, total gallons used.

If you have a fuel management system installed on your boat, please refer to the engine or fuel management manual for detailed information on that system.

Compass

Your boat is equipped with a binnacle style compass. To adjust the compass for your area, read the instructions on "Compass Compensation" given to you in the literature packet. The compass cannot be adjusted accurately at the factory as it must be compensated for the influence of the electrical equipment and electronics unique to your boat. Therefore, the compass should be adjusted by a professional after the electronics and additional electrical accessories are installed and before operating the boat.

Instrument Maintenance

Electrical protection for instruments and ignition circuitry is provided by a set of circuit breakers located near the main battery switch. The ignition switches should be sprayed periodically with a contact cleaner/lubricant. The ignition switches and all instruments, controls, etc. should be protected from the weather when not in use. Excessive exposure can lead to gauge and ignition switch difficulties.



Helm Station

Chapter 2:

HELM CONTROL SYSTEMS

2.1 General

The helm controls consist of three systems: the engine throttle and shift controls, the steering system, and the trim tab control switches. These systems provide the operator with the ability to control the direction and attitude of the boat from the helm station.

Each manufacturer of the control components provides an owner's manual with its product. It is important that you read the manuals and become familiar with the proper care and operation of the control systems.

2.2 Engine Controls

The shift and throttle controls on your boat may vary depending on the engine used. The following control description is typical of most outboard remote controls. Refer to the engine or control manuals for specific information on the controls installed on your Wellcraft.

The engine throttle and shift control system consist of three major components: the control handles, the throttle cable and the shift cable. The cables are all the push-pull type. Two cables are required for each engine. One cable connects the remote throttle control to the carburetor or fuel injectors and the other connects the remote shift control to the engine shift rod linkage.

The helm on your Wellcraft is designed for a binnacle style control with a single lever that operates as a gear shift and a throttle. General operation will include a position for neutral (straight up and down), a forward position (the 1st detent forward of neutral), and a reverse position (the 1st detent aft of neutral). Advancing the control lever beyond the shift range advances the throttle in forward or reverse. Each control is equipped with a means of permitting the engine to be operated at a higher than idle RPM while in neutral for cold starting and warm-up purposes.

2.3 Neutral Safety Switch

Every control system has a neutral safety switch incorporated onto it. This device prohibits the engine from being started while the shift lever is in any position other than the neutral position. If the engine will not start, slight movement of the shift lever may be necessary to locate the neutral position and disengage the safety cutout switch. Control or cable adjustments may be required to correct this condition should it persist.

See your Wellcraft dealer for necessary control and cable adjustments.

The neutral safety switches should be tested periodically to ensure that they are operating properly. To test the neutral safety switches, make sure the engine is tilted down and move the shift lever to the forward position.

Make sure the throttle control lever is not advanced past the idle position. Turn the ignition key to the start position just long enough to briefly engage the starter for the engine. **Do not hold the key in the start position long enough to start the engine.** The starter should not engage the engine. Repeat this test with the shift lever in reverse and the engine throttle at idle. Again, the starter should not engage. If the starter engages with the shift control in any position other than the neutral position, then the neutral safety switch is not functioning properly and you should contact your dealer to have the neutral safety switch repaired by a qualified marine mechanic before using the boat. If the engine starts in gear during this test, immediately move the control lever to the neutral position and turn the engine off.

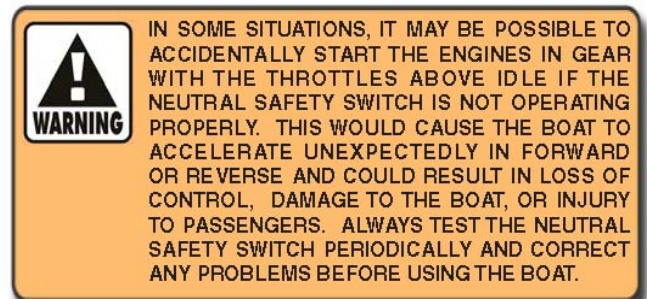

2.4 Engine Power Tilt and Trim

All outboard engines have a tilt and trim feature. Most outboard engines have tilt/trim switches built into the engine shift and throttle controls that allow the operator to control the position of the outboards from the helm.

Moving the outboard closer to the boat transom is called trimming "in" or "down". Moving the outboards further away from the boat transom is called trimming "out" or "up". In most cases, the boat will run best with the outboards adjusted so the hull will run at a 3 to 5 degree angle to the water.

The term “trim” generally refers to the adjustment of the outboard within the first 20 degree range of travel. This is the range used while operating your boat on plane. The term “tilt” is generally used when referring to adjusting the outboard further up for shallow water operation or trailering. For information on the proper use and maintenance of the power tilt and trim please refer to the engine owner’s manual.

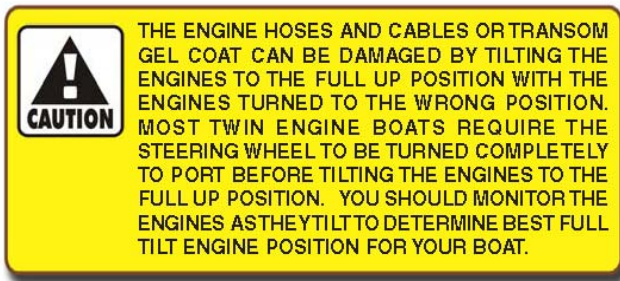

2.5 Engine Stop Switch

Your boat is equipped with an engine stop switch and lanyard. When the lanyard is pulled it will engage the switch and shut off the engines. We strongly recommend that the lanyard be attached to the driver whenever the engine is running. If the engine will not start, it could be because the lanyard is not properly inserted into the engine stop switch. Always make sure the lanyard is properly attached to the engine stop switch before attempting to start the engine.

Refer to the engine owner’s manual for more information on the engine stop switch.

2.6 Steering System

The steering system is hydraulic and made of two main components: the helm assembly and steering cylinder. The helm unit acts as both a fluid reservoir and pump. Turning of the helm. Or steering wheel, pumps the fluid in the hydraulic hoses and activates the hydraulic steering cylinder causing the motors to turn. A slight clicking sound may be heard as the wheel is turned. This sound is the opening and closing of valves in the helm unit and is normal.

The steering wheel can be tilted to five different positions by activating the tilt lock lever located on the bottom side of the helm station. When the lever is released, it automatically locks the steering wheel at or close to that angle. Refer to the steering manufacturer owner’s manual for specific information on the steering system.

2.7 Control Systems Maintenance

Control Maintenance

Periodic inspection of the control systems and all connections should be made. Signs of rust, corrosion, wear, or other deterioration should immediately be serviced. Generally, periodic lubrication of all moving parts and connections with a light waterproof grease is in order. Lubrication should be performed as often as necessary to keep the system operating smoothly.

Control system adjustments may become necessary. If adjustments become necessary, see your Wellcraft dealer.

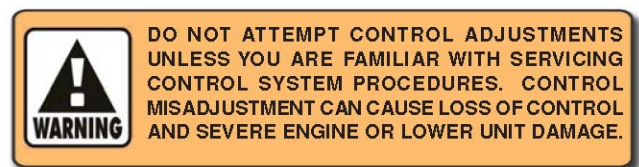

Steering System Maintenance

A periodic inspection of all steering hoses, linkage and helm assemblies should be made. Signs of corrosion, cracking, loosening of fastenings, excessive wear, or deterioration should be immediately corrected. Failure to do so could lead to steering system failure that would result in loss of control.

When new, or after repairs, hydraulic steering systems may need to have all air purged from the system. Check the steering fluid level in the helm, it should be maintained at no less than ½” below the bottom of the filler cap threads. Only use hydraulic steering fluid recommended by the steering system manufacturer.

Remove, clean and grease the support tube and rod annually with quality marine grease. Refer to the hydraulic steering manufacturer owner’s manual for proper specifications and details on system service and maintenance.

Chapter 3:

FUEL SYSTEM

3.1 General

The fuel system used in Wellcraft boats is designed to meet or exceed the requirements of the U.S. Coast Guard, the National Marine Manufacturer's Association, and The American Boat and Yacht Council in effect at the time of manufacturer.

All fuel systems have been factory inspected and pressure tested in accordance with regulations in effect at the time of manufacture. This inspection assures that the system is air tight, leak proof and safe. It is the responsibility of the purchaser to maintain it in that condition. Make frequent inspections to assure that no deterioration or loosening of connections is resulting from vibration.

Fuel Withdrawal Tube

The fuel withdrawal tube is positioned in the fuel tank to achieve optimum fuel usage, fuel line routing, etc. At certain speeds and hull trim angles, the fuel supply at the withdrawal tank location can increase or decrease accordingly. Be extremely careful when attempting to operate the boat when low on fuel. Though some fuel may be in the tank, the relative trim angle of the boat may cause the fuel to flow away from the withdrawal tube.

There is an on/off valve for the supply lines located on the rear of each fuel tank near the withdrawal tube. The valve provides a means to turn off the fuel supply when servicing the fuel system. The small access hatch provides access to the fuel valve, and fuel gauge sending unit. The fuel filters are accessed through access hatches at the rear of the boat.

Fuel Gauges

The fuel gauges indicate the amount of fuel in the tanks. Due to the mechanical nature of the fuel sender, variations in reading during various speeds of operation may occur. This system is merely a relative indication of the available fuel supply and not a calibrated instrument.

Your boat is equipped with one fuel gauge sender. There are analog or digital fuel gauges at the helm that monitor the fuel level.

Fuel Fill

Fuel fill deck plate is located on the starboard gunnel and is marked "GAS". The fuel fill is opened by turning it counter clockwise with a special key. After fueling, install the fuel cap and tighten with the key. Be sure to use the proper type and grade fuel. Refer to the engine owner's manual for additional information.

Note: Do not over tighten the fuel cap. If the cap is over tightened, the O-ring seal could be damaged allowing water to contaminate the fuel system.

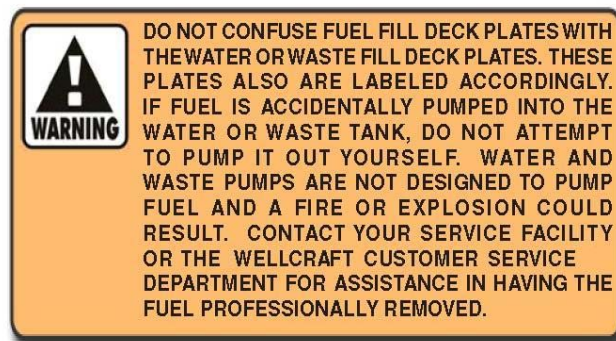

3.2 Engine Fuel Supply System

The fuel system includes a fuel tank, water separating fuel filter and a manual "ON/OFF" fuel valve at the pickup tube on the fuel tank. The valve is off when the handle is perpendicular to the fuel flow. The fuel filter is located in the stern bilge just below the splash well.

The fuel valve is located on the top rear of the fuel tank. The valve should be open unless it needs to be closed in the event of a fuel leak or to service the fuel system.

Fuel withdrawal line is equipped with a manual shut off valve where the line attaches to the fuel tank. These valves prevent gasoline from siphoning out of the fuel tank should a line rupture.

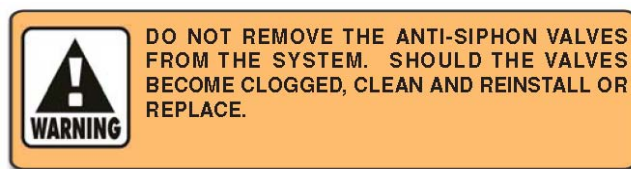

Fuel Filter

The filter is a spin on, water separator type. It is recommended that the filter is inspected periodically and the elements changed at least once every year or as necessary.

See Fuel System maintenance and the engine owner's manual for additional information on the fuel filters.

Note: Some fuel injected engines have fuel filters on the engine and do not allow external filters. If your boat is equipped with a fuel injected engine, it may not have a separate water separator fuel filter.



TO REDUCE THE POSSIBILITY OF A FIRE OR EXPLOSION, MAKE SURE ALL ELECTRICAL SWITCHES ARE IN THE "OFF" POSITION BEFORE SERVICING THE FUEL SYSTEM.



DO NOT DRAIN ANY FUEL IN THE BILGE. THIS COULD LEAD TO A FIRE OR EXPLOSION.

CHECK ALL FUEL LINE FITTINGS FOR LEAKS BEFORE AND AFTER STARTING THE ENGINES FOLLOWING ANY FUEL SYSTEM SERVICE.

3.3 Fueling Instructions



FUEL IS VERY FLAMMABLE. BE CAREFUL WHEN FILLING THE FUEL TANKS. NO SMOKING. NEVER FILL THE TANKS WHILE THE ENGINES ARE RUNNING. FILL THE FUEL TANKS IN AN OPEN AREA. DO NOT FILL THE TANKS NEAR OPEN FLAMES.



TO PREVENT DAMAGE TO THE FUEL SYSTEM, USE ONLY A GOOD GRADE OF GASOLINE FOR GASOLINE ENGINES. DO NOT USE A FUEL THAT CONTAINS HARSH ADDITIVES OR IS AN ALCOHOL BLEND. ANY DAMAGE DONE TO THE FUEL SYSTEM THAT IS THE RESULT OF USE OF AN ALCOHOL BLEND, IS NOT COVERED BY THE HYDRA-SPORTS WARRANTY. REFER TO THE ENGINE MANUFACTURER OWNER'S MANUAL REGARDING FUEL REQUIREMENTS FOR YOUR ENGINES.



STATIC ELECTRICITY CAN BE GENERATED WHILE FUELING AND CAN CAUSE A FIRE OR EXPLOSION. TO PREVENT STATIC SPARKS WHEN FILLING THE TANK, MAKE SURE THE NOZZLE IS IN CONTACT WITH THE FUEL FILL OPENING.



SPILLED FUEL IS DANGEROUS AND CAN YELLOW FIBERGLASS OR IGNITE. MAKE SURE YOU DO NOT SPILL ANY FUEL. IF FUEL IS SPILLED ON THE DECK, USE A CLOTH TO REMOVE THE FUEL AND PROPERLY DISPOSE OF THE CLOTH ON SHORE. IF FUEL IS SPILLED ON THE WATER, EXERCISE EXTREME CAUTION. FUEL FLOATS ON TOP OF THE WATER AND CAN IGNITE. IF EXCESS FUEL IS SPILLED INTO THE WATER, IMMEDIATELY EVACUATE THE AREA AND NOTIFY THE MARINA AND THE PROPER OFFICIALS.

9. Fill the fuel tanks slightly less than the rated capacity to allow for expansion and to avoid spilling fuel out of the vents and fuel fills.
10. Remove the nozzle.
11. Install and tighten the fuel cap. Be careful not to over-tighten the cap.
12. Check the fuel compartment and below the deck for fuel odors. If you smell fuel, do not start the engine.



TO REDUCE THE RISK OF A FIRE AND/OR EXPLOSION, DO NOT START THE ENGINES WHEN FUEL FUMES ARE PRESENT. FUEL FUMES ARE DANGEROUS AND HARMFUL TO YOUR HEALTH.



MAKE SURE ALL GASOLINE ODORS ARE INVESTIGATED IMMEDIATELY.

To fill the fuel tank at a marina, follow this procedure:

1. Make sure all switches are in the "OFF" position.
2. Make sure the boat is securely moored.
3. Make sure all passengers leave the boat.
4. Estimate how much fuel is needed and avoid over filling.
5. A special key to open the fuel cap is supplied. Turn the key counterclockwise to open the cap.
6. Remove the cap.
7. Put the nozzle in the fuel opening.

3.4 Fuel System Maintenance

Periodically inspect all connections, clamps and hoses for leakage and damage or deterioration. Replace as necessary. Spray the valves, fuel tank gauge sender and ground connections with a metal protectant.

Frequently inspect and lubricate the fuel fill cap O-ring seals with petroleum jelly or silicone grease. The O-ring seal prevents water from entering the fuel system through the fuel fill cap and it should be replaced immediately if there is any sign of damage or deterioration.

Contaminated fuel may cause serious damage to your engine. The filter must be checked for water and other contamination frequently. The filter elements must be changed at least once a season or more frequently depending on the type of engine and the quality of the fuel. Please refer to the engine or fuel filter manufacturer's instructions for information on servicing and replacing the fuel filter elements.

The age of gasoline can affect engine performance. Chemical changes occur as the gasoline ages that can cause deposits and varnish in the fuel. Severely degraded fuel can damage the engine and boat fuel tank and lines. Therefore, if your boat is not being run enough to require at least one full tank of fresh fuel a month, a fuel stabilizer should be added to the gasoline to protect the fuel from degradation. Your dealer or the engine manufacturer can provide additional information on fuel degradation and fuel stabilizers recommended for your engine.



DO NOT DRAIN ANY FUEL INTO THE BILGE WHEN SERVICING THE FUEL SYSTEM. THIS COULD LEAD TO A FIRE OR EXPLOSION.



AFTER THE FILTER ELEMENT HAS BEEN CHANGED, PRIME THE FUEL SYSTEM AND CHECK ALL FITTINGS FOR LEAKS BEFORE AND AFTER STARTING THE ENGINES.



BEFORE STARTING THE ENGINES, ALWAYS OPEN ALL HATCHES, WINDOWS, AND DOORS TO COMPLETELY VENTILATE THE BOAT AFTER SERVICING THE FUEL SYSTEM.



TO AVOID SERIOUS INJURY OR DEATH FROM FIRE OR EXPLOSION RESULTING FROM LEAKING FUEL, INSPECT FUEL SYSTEM AT LEAST ONCE EACH YEAR.

Chapter 4:

ELECTRICAL SYSTEMS

4.1 General

Your boat is designed for 12-volt lead acid, wet cell marine batteries. They will require similar maintenance as those found in automobiles. You should not mix the size or brand of the wet cell batteries. Always consult your Wellcraft dealer before changing the type of batteries in your boat.

All wires in the electrical systems are color coded to make identifying circuits easier. Wiring schematics and a wire code identification list have been included with this manual to aid in following an individual circuit of the boat.

4.2 12-Volt System

The 12-volt system is a typical marine system equipped with two batteries. The batteries are charged by the engine.

All 12-volt power is distributed to the 12-volt accessories through individual circuit breakers located in the head compartment near the battery switch. Main fuses protect the primary DC circuits from an overload.

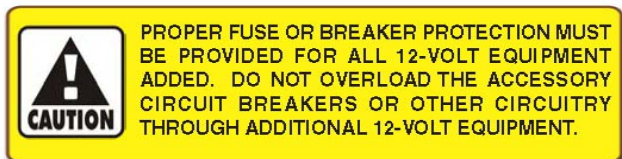

Single Battery Switch

The battery switch (OFF - 1 - 2 – BOTH) is located in the head compartment. The following is a general usage of this battery switch.

In the **OFF** position, the two batteries are disconnected from all loads. The OFF position is used when the boat is being stored or otherwise not in use. It prevents any drain from the batteries. This can be useful if a circuit has been accidentally left on, say a cabin lighting circuit or similar drain. Such a load can completely discharge a battery in a day or two, leading to an unanticipated dead battery situation when you return to your boat.

In the **1** position, all loads and charging currents are connected to the No. 1 battery. Starting current for the engine starter motor is supplied by the PORT battery. When the engine is running, surplus current developed by its charging circuit will flow into the PORT battery. Current to lighting and other loads will flow from the PORT battery. The STDB battery is completely isolated



Battery Switch

and has no load current, nor does it receive any charging current.

In the **2** position, all loads and charging currents are connected to the No. 2 battery. Now it supplies current required by starting and running, and it receives all the charging current from the engine. The PORT battery is totally isolated.

In the **BOTH** position, the two batteries are connected in parallel. This has a number of implications. Unless the batteries have exactly the same state of charge, the combined voltage to the two batteries in parallel will sag to a voltage somewhat lower than the highest battery's terminal voltage. Current from the higher voltage battery will flow into the lower voltage battery and begin charging it. As long as the state of charge in one battery is higher than the other, the lower battery is more of a load than a source of power. Eventually, the batteries will reach equilibrium, and they will both have the same terminal voltage. At that point they will both tend to supply current to loads that are attached to them, and they will both receive charging current furnished by the engine.

It would seem like operating in the BOTH position would be beneficial, but that is not always the case. Even though the batteries will eventually rise or fall to the same terminal voltage when connected together, they will not necessarily become exactly the same. A battery (or any source of electrical energy) can be thought of as having an internal resistance. The lower this internal resistance the greater the current it can supply. The internal resistance will also affect how the battery absorbs charging current. Even though they are connected in parallel, it is possible that they will supply unequal currents to the loads, and it is also possible that

they will accept unequal currents from the engine charging source.

If the batteries are significantly different in their age, their type of construction, and their state of charge, this unequal distribution of current can be more significant. To describe the situation in the simplest of terms, when two batteries are connected in parallel, they will probably tend to behave more like the weakest battery of the two than the strongest.

Paralleling the batteries can come in handy in some situations. For example, both batteries may be discharged to a point where neither alone can provide enough current to crank the starter motor, but combined in parallel they can turn the engine over.

If one battery is fully charged and the other is totally discharged, connecting them in parallel (by using the BOTH position) can cause very high currents to flow between the batteries. Extreme heat can be generated by the sudden charging of the discharged battery. Use caution in this situation. It is better to recondition a discharged battery by slowly re-charging it with an AC-operated battery charger.

The arrangement of the contacts of the typical OFF-1-2-BOTH permits the operation of the switch in the range of 1-2-BOTH without ever disconnecting the batteries from the load or the outboard charging circuit. This is important, as it is possible to cause damage to the charging circuit if the battery is disconnected while the engine is running. By choosing the path of rotation of the switch, it is possible to change from 1 to 2 without moving through the OFF position.

4.3 12-Volt Accessory Switch Panel

Helm Switch Panel

The helm switch panel is located at the helm.

Note: Next to each switch is a circuit protection breaker that can be reset by pushing in the button.

The following is a description of the accessories controlled by the helm switch panel:

Horn

Activates the boat horn

Anchor/Nav Lights

The switch is a three position switch. The middle position is "OFF". Moving the switch up activates the navigation, instrumentation and compass lighting. Moving the switch to the down position activates the anchor light.



Helm Switch Panel

Courtesy Lights

This switch turns on or off the boat's courtesy lighting.

Bilge

Activates the bilge pump located in the stern bilge.

Fishbox

Activates the macerator pump located in the stern bilge.

Standard Baitwell

Supplies power to the standard livewell pump and light.

Optional Baitwell

Supplies power to the Optional livewell pump and light.

Raw Water / Fresh Water

Supplies power to the boat's raw water washdown pump and fresh water system pump.

Spreader Light

Activates the forward flood light located on the T-Top if installed. This light provides lighting for the forward deck area.

Wiper

Turns on and off windshield wiper

Accessory

Supplies power to any customer supplied equipment of 12-volt outlet.

12 Volt Receptacle

Chapter 5:

DRAINAGE SYSTEM

5.1 General

All water is drained to overboard thru-hull fittings located in the hull. Some cockpit component drain thru-hull fittings are equipped with ball valves that are always open under normal operating conditions. It is important to check and operate the drain valves at least annually to make sure they are in good condition and operating properly. You also should check the drain system frequently to ensure it is free flowing and that the hoses on the thru-hull fittings are secure and not leaking.

The cabin sinks drain to the drain sump system below the cabin sole. The cabin sump, and most cockpit components drain to fittings in the hull.

5.2 Bilge Drainage

Bilge Pumps and Drainage

The bilge pumps are activated both manually by switches in the helm station and automatically by float switches located next to the pumps. The automatic float switches are connected to the batteries. They are protected by circuit breakers located on the helm switch panel. The manual switches are supplied current when the battery switches are activated. An LED light in each switch in the helm indicates when the pump is operating. The manual circuit is protected by the breaker in the helm accessory breaker panel.

All bilge pumps pump water out of thru-hulls located above the waterline in the hull. The rear bilge pump and automatic switch is located in the rear bilge area. The forward bilge pump and automatic switch is located under the cabin sole below a hatch near the fresh water tank.

Note: See **Electrical Systems** for additional information on bilge pump operation.

Note: Any oil spilled in the bilge must be thoroughly removed and properly disposed of before operating the bilge pump. The discharge of oil from the bilge is illegal and subject to a fine.

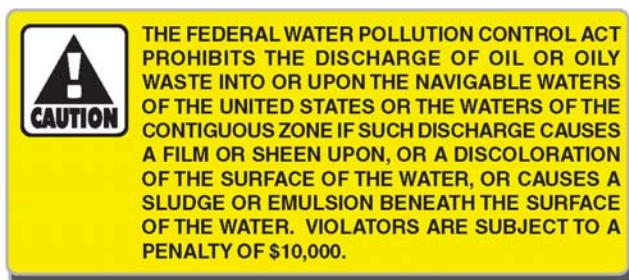

5.3 Cockpit and Deck Drains

Scuppers and Cockpit Hatches

Your Wellcraft has two scupper drains located in the rear of the cockpit at the transom. Flaps built into the scuppers help reduce the surge of sea water through the scuppers and into the cockpit.

Fishboxes , Baitwell, and Cockpit Sink Drains

The fishboxes below the cockpit floor are drained overboard by a macerator pump out system. The macerator is activated by a switch located in the helm switch panel. Monitor the water level as the macerator drains the fishboxes and turn the pump off immediately when draining is complete. The pump could be damaged if it is allowed to run dry for extended periods.

The baitwell, and cockpit bait prep sink are drained by gravity to thru-hull fittings in the hull side. The overflow in the baitwell drains into the overboard drains.

Rope Locker Drains

The rope locker drains overboard through a drain fitting located in the hull side at the bottom of the rope locker. It is important to inspect the drain frequently to remove any accumulated debris.

5.4 Cabin Drains

The galleys sink drains overboard through a thru-hull fitting.

5.5 Drainage System Maintenance

It is essential that the following items be done periodically to maintain proper drainage of your boat:

- Clean the cockpit deck drain with a hose to remove debris that can block water drainage.
- Clean the hardtop leg drain holes. This is especially important just before winter lay-up.
- Clean the bilge pump strainers of debris and check the bilge for foreign material that can cause the automatic switches to malfunction.
- Frequently test the automatic bilge pump switches for proper operation. This is accomplished by lifting the float switch until the pump is activated. You can also use a garden hose to flood the bilge until the water level is high enough to activate the pump.
- Flush all gravity drains with freshwater to keep them clean and free flowing.

- Clean and inspect the cabin drain sump system. Remove accumulated debris and flush with freshwater. Frequently test the automatic pump switch for proper operation.
- Clean and flush the fishbox and cooler/storage boxes with soap or a bilge cleaner and freshwater after each use to keep them clean and fresh.
- Operate the thru-hull valves once a month and service as required.

Note: All drains and pumps must be properly winterized before winter lay-up.

Note: Never use harsh chemical drain cleaners in marine drain systems. Permanent damage to the hoses and fittings may result.

Chapter 6:

VENTILATION SYSTEM

6.1 Cabin Ventilation

Ventilation to the cabin area is provided by a deck hatch and port windows.

Deck Hatch

The deck hatch in the cabin is supported in the open position by an adjustable hatch adjuster. It is secured in the closed position by cam levers on the inside of the hatch. To open the hatch, rotate the cam levers to the open position. Raise the hatch and secure it by tightening the hatch adjuster. To close the hatch, loosen the hatch adjuster and lower the hatch. Secure in the closed position with the cam levers.

The cam levers can secure the hatch in two positions, the vent position or fully closed. The hatch is secured in the vent position by opening hatch slightly until the cam levers align with the notch in the hatch frame just above the fully closed, watertight position. With the cam levers secured in this position, the hatch will be open just enough to let air circulate into the cabin. Always secure the hatch in the water tight position when leaving the boat unattended or when running offshore.

When the hatch is open, a removable screen can be installed in the hatch trim ring to prevent insects from entering the cabin.

Port Windows

Opening port windows are located in the cabin. Each window opens to provide ventilation into the cabin area and is equipped with a removable screen.

The windows are secured by adjustable cam levers. The cam levers should be adjusted so they are tight enough to seal the windows in the closed position, but not so tight that the window becomes difficult to secure.

Always make sure the windows are closed and secured with the cam levers whenever the boat is underway. Sea spray could enter the cabin through an open window and damage upholstery, and cabin equipment.

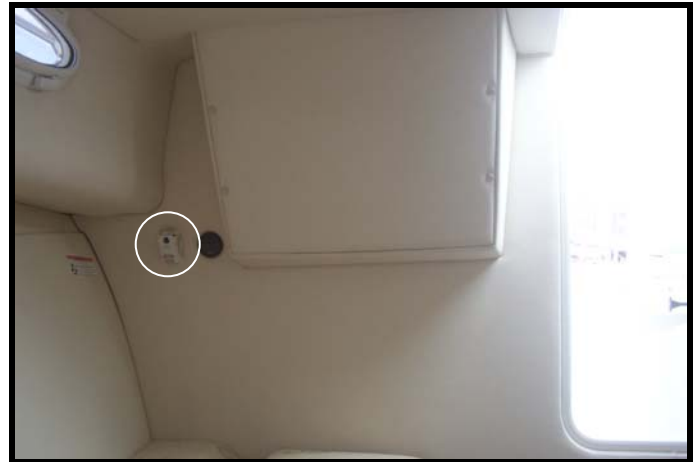

Carbon Monoxide Detector

6.2 Carbon Monoxide and Proper Ventilation

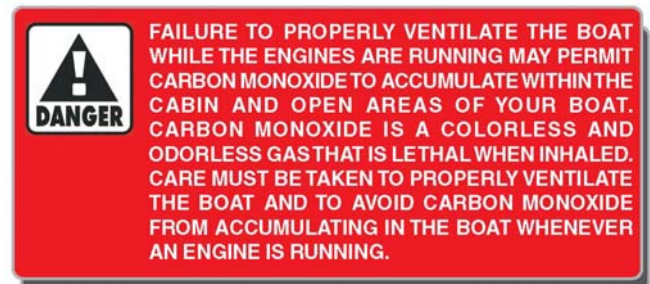

A by-product of combustion, carbon monoxide (CO) is invisible, tasteless, odorless, and is produced by all engines and gas heating and cooking appliances. The most common sources of CO on boats are gasoline and diesel engines, auxiliary generators and propane or butane stoves. These produce large amounts of CO and should never be operated while sleeping. The hazard also may be created by a boat nearby whose exhaust fumes are entering your boat. Boats also have a problem due to the "station wagon effect" where engine exhaust fumes are captured in the vacuum or low pressure area, usually the cockpit, bridge deck and cabin, which can be created by the forward speed of the boat.

Boats underway should close all aft facing hatches and doors. The forward facing deck hatches should be open whenever possible to help pressurize the living spaces of the boat. No sleeping in the cabin should be permitted while underway. Proper ventilation should be maintained on the bridge deck by opening windshield or forward clear connector vents, as far as possible to help pressurize the cockpit area. The canvas drop or aft curtain must be removed and the side curtains should be opened or removed to increase air flow and maintain proper ventilation whenever the engines are running. ***Under no circumstances should the engines be operating with side curtains closed and the aft or drop curtain installed.***

Extreme caution must be taken while at anchor or in a slip. Wind still nights can easily allow exhaust fumes, containing high concentrations of CO, from an adjacent boat's generator to enter the boat. The exhaust fumes may enter your boat through open hatches or windows. A carbon monoxide detector has been installed in your cabin as standard equipment. While a CO detector enhances your protection from CO poisoning, it does not guarantee it will not occur.

Do not use the carbon monoxide detector as a replacement for ordinary precautions or periodic inspections of equipment. Never rely on alarm systems to save your life, common sense is still prudent and necessary. Remember, the operator of the boat carries the ultimate responsibility to make sure the boat is properly ventilated and the passengers are not exposed to dangerous levels of carbon monoxide. You should always be alert to the symptoms and early warning signs of carbon monoxide poisoning. You also should read the "Carbon Monoxide Monitoring System" in the Safety Equipment chapter of this manual, and the owner's manual supplied by the CO detector manufacturer for operation instructions and additional information regarding the hazards and symptoms of carbon monoxide poisoning.

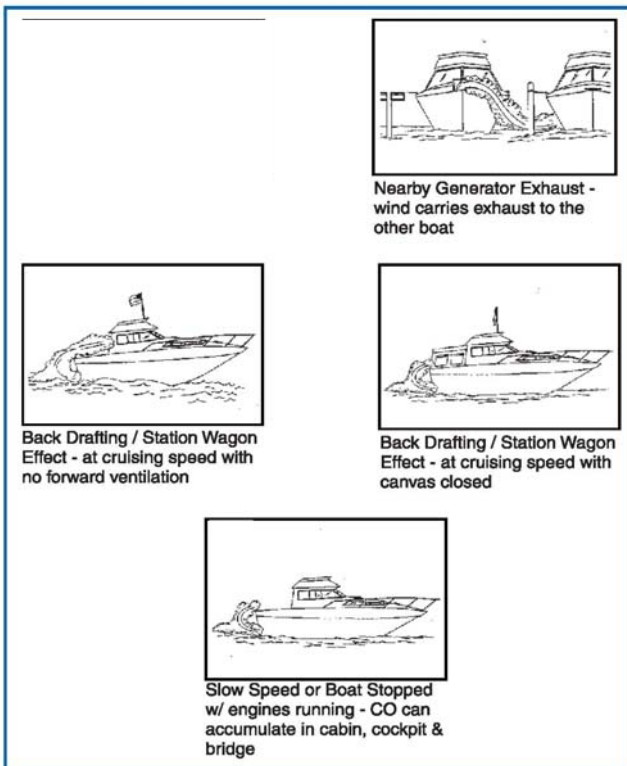
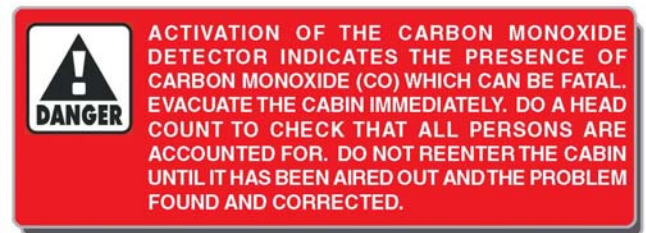

Periodically test the carbon monoxide alarm per the manufacturer's instructions. Please refer to the carbon monoxide alarm manual or contact the manufacturer for more information on maintaining and calibrating the alarm.

6.3 Maintenance

- Periodically lubricate all hinges and latch assemblies with a light oil.
- Periodically clean and coat gasket materials with silicone to help keep them pliable.
- The opening cabin deck hatches and the cabin door are made of acrylic plastic glass. Acrylic glass scratches easily. Never use a dry cloth or glass cleaning solutions on acrylic glass. Use a soft cloth and mild soap and water for routine cleaning. Solvents and products containing ammonia can permanently damage acrylic glass. Please refer to the Routine Maintenance chapter for more information on the proper maintenance for acrylic plastic glass.

Chapter 7:

EXTERIOR EQUIPMENT

7.1 Deck

Rails and Deck Hardware

The rail system and hardware fittings have been selected and installed to perform specific functions. Recessed hand rails and other grab rails are installed to provide a handhold in certain areas of the boat. You should make sure you keep at least one hand on the handholds as you move about the boat.

Mooring lines should be secured to the cleats and not to rails or stanchions. Be sure a clear lead exists when running dock or anchor lines. A line inadvertently run around a stanchion or over the rail could cause damage.

Note: All fittings must be inspected periodically for loose fit or wear and damage. Any problems should be corrected immediately.

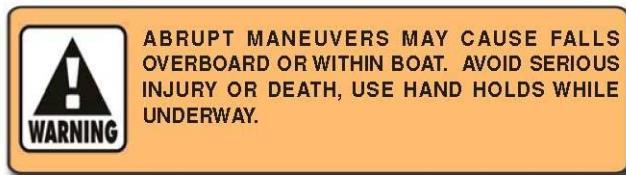
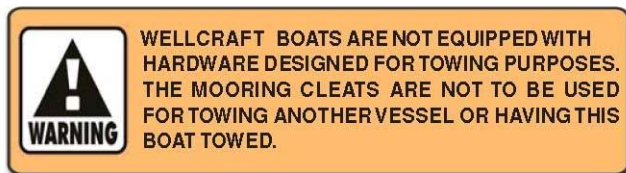

Anchor Rope Locker

The anchor rope locker is in the bow of the boat and accessed through a hatch in the cabin. The anchor line is always stored in the locker and the anchor should be stored on the bow roller.

The anchor rope locker is drained by a thru-hull fitting near the bottom of the locker. It is very important to check the drain frequently to make sure it is clean and free flowing.

Periodically remove the anchor line from the rope locker, rinse it with freshwater and allow it to dry in the sun. Cleaning the anchor line regularly will reduce odors in the anchor rope locker and increase the life of the line.



Anchor Rope Locker Hatch



Anchor Roller

The line should also be inspected for abrasions or signs of deterioration. Replace the line if it shows any sign of damage or deterioration. Make sure the bitter end of the anchor line is secured to the special fitting in the locker when you reinstall it.

Anchor Roller

The anchor roller assembly is mounted on the bow and allows the anchor to be operated and stored at the roller. Always make sure the anchor is properly secured when it is in the stored position on the bow roller.

7.2 Hull

Boarding Ladder

The standard boarding ladder is installed on the starboard transom. It is held in the storage position by a retaining strap. To use the ladder you will need to undo the strap and fold out the ladder.



CARBON MONOXIDE (CO) CAN CAUSE BRAIN DAMAGE OR DEATH. ENGINE EXHAUST CONTAINS ODORLESS AND COLORLESS CARBON MONOXIDE GAS. CARBON MONOXIDE WILL BE AROUND THE BACK OF THE BOAT WHEN ENGINES ARE RUNNING. MOVE TO FRESH AIR IF YOU FEEL NAUSEA, HEADACHE, DIZZINESS, OR DROWSINESS.



MOVING PROPELLERS ARE DANGEROUS. THEY CAN CAUSE DEATH, LOSS OF LIMBS, OR OTHER SEVERE INJURY. DO NOT USE THE SWIM PLATFORM OR SWIM LADDER WHILE THE ENGINES ARE RUNNING. STOP THE ENGINES IF DIVERS OR SWIMMERS ARE ATTEMPTING TO BOARD. ALWAYS PROPERLY STORE THE LADDER BEFORE STARTING THE ENGINES.



Boarding Ladder

7.3 Cockpit

General

The hatches in the cockpit sole deck are secured with twist latches and flush mounted handles that store flush in the hatch. Automatic push to close latches or draw latches secure other cockpit hatches in the closed position. Gas charged springs or spring struts are used to help raise most hatches and hold them in the open position.

Some hatch latch handles must be rotated to the correct position to store flush. Other hatches require firm down pressure to secure the push to close latches. Always make sure the hatches are secured with the latches and that the handles are in the flush position before operating the boat above idle speed.



210 Coastal Cockpit



IN CERTAIN CONDITIONS, OPEN EXTERIOR DOORS AND HATCHES THAT ARE NOT SECURED PROPERLY CAN SLAM CLOSED UNEXPECTEDLY AND CAUSE INJURY TO PASSENGERS OR DAMAGE TO THE BOAT. MOST DOORS AND HATCHES ARE EQUIPPED WITH SPECIAL FASTENERS, HATCH LIFTERS, SNAPS OR STRAPS, TO SECURE THEM IN THE OPEN POSITION. ALWAYS MAKE SURE THAT THESE HATCHES AND DOORS ARE PROPERLY SECURED WHENEVER THEY ARE IN THE OPEN OR CLOSED POSITIONS.

Chapter 8:

INTERIOR EQUIPMENT

8.1 Self Contained Head

The 210 Coastal is equipped with a covered self contained head as standard equipment. Please refer to the toilet manufacturer owner's manual for more information on proper operation and functions.

Maintenance

Lubricate slide valve seals periodically with silicone spray or paste lubricant. The slide valve may be removed for cleaning or inspection by simply unscrewing counterclockwise. Clean exterior of toilet with a mild non-abrasive bathroom cleaner.

8.2 Cabin and V-Berth

Galley and Sink (Option Only)

The galley is equipped with a single lever faucet with cold water only. Water is supplied to the sink by a 12-volt pump located in the bilge. When activated by the Fresh Water Switch located on the Helm Switch Panel, the water system will operate much like the water system in a home. An automatic pressure sensor keeps the system pressurized. The sink drains overboard through the cabin drain sump system. See the Fresh Water System chapter for more information on operating the fresh water system.

Daylight and fresh air is provided to this area by an overhead hatch, port light windows and the cabin door. The hatch is equipped with a removable screen. Refer to the Ventilation System chapter for more information on the hatch and screen.

V-Berth

The V-berth and dinette table is located in the forward area of the cabin. An access hatch for the rope locker, speakers are located on the forward V-berth bulkhead.

Daylight and fresh air is provided to this area by an overhead opening hatch. Refer to the Ventilation Systems chapter for more information on operation of the hatches and screens.



Self Contained Head



210 Coastal V-Berth

Carbon Monoxide Detector

A carbon monoxide (CO) detector is installed in the cabin. If excess carbon monoxide fumes are detected, an audible beeping will sound indicating the presence of the toxic gas. This detector is always activated when the batteries are connected and is protected by the continuous power CO Detector breaker in the cabin DC breaker panel. A green light on the detector indicates that it is activated. Always make sure the green light is on whenever the cabin is occupied.

A by product of combustion, carbon monoxide is invisible, tasteless, odorless, and is produced by all engines and some heating and cooking appliances. The most common sources of CO on boats are the engines and auxiliary generators and propane or butane stoves. These produce large amounts of CO and should never be operated while sleeping.

You should read the owner's manual supplied by the detector manufacturer for operation instructions and additional information regarding the hazards of carbon monoxide gas. Also read more about carbon monoxide, carbon monoxide detectors, and proper ventilation in the Ventilation System and Safety Equipment chapters in this manual.



210 Coastal Carbon Monoxide Detector Location



ACTIVATION OF THE CARBON MONOXIDE DETECTOR INDICATES THE PRESENCE OF CARBON MONOXIDE (CO) WHICH CAN BE FATAL. EVACUATE THE CABIN IMMEDIATELY. DO A HEAD COUNT TO CHECK THAT ALL PERSONS ARE ACCOUNTED FOR. DO NOT REENTER THE CABIN UNTIL IT HAS BEEN AIRED OUT AND THE PROBLEM FOUND AND CORRECTED.

Chapter 9:

SAFETY EQUIPMENT

9.1 General

Your boat has been equipped with safety equipment designed to enhance the safe operation of the boat and to meet U.S. Coast Guard safety standards. The Coast Guard or state, county, and municipal law enforcement agencies require certain additional accessory safety equipment on each boat. This equipment varies according to length and type of boat and type of propulsion. The accessory equipment typically required by the Coast Guard is described in this chapter. Some local laws require additional equipment. It is important to obtain "Federal Requirements And Safety Tips for Recreational Boats", published by the Coast Guard, and copies of state and local laws, to make sure you have the required equipment for your boating area.

9.2 Required Safety Equipment

Besides the equipment installed on your boat by Wellcraft, certain other equipment is required by the U.S. Coast Guard to help ensure passenger safety. Items like a sea anchor, working anchor, extra dock lines, flare pistol, life vests, a line permanently secured to your ring buoy, etc., could at some time save your passengers' lives, or save your boat from damage. Refer to the "Federal Requirements And Safety Tips for Recreational Boats" pamphlet for more detailed description of the required equipment. You also can contact the U.S. Coast Guard Boating Safety Hotline, 800-368-5647, for more information on boat safety courses and brochures listing the Federal equipment. Also, check your local and state regulations.

The Coast Guard Auxiliary offers a "Courtesy Examination". This inspection will help ensure that your boat is equipped with all of the necessary equipment. The following is a list of the accessory equipment required on your boat by the U.S. Coast Guard.

Personal Flotation Devices (PFDs)

PFDs must be Coast Guard approved, in good and serviceable condition, and of appropriate size for the intended user. Wearable PFDs must be readily accessible, meaning you must be able to put them on in a reasonable amount of time in an emergency. Though not required, the Coast Guard emphasizes that PFDs should be worn at all times when the vessel is underway. Throwable devices must be immediately available for use. All Wellcraft boats must be equipped with at least one Type I, II or III PFD for each person on board, plus one throwable device (Type IV)



Throwable Device and Personal PFD

In addition to the requirements set by the Coast Guard, individual states may have additional requirements for children and specific types of recreational activity. Please visit www.nasbla.org for state laws.

Visual Distress Signals

All boats used on coastal waters, the Great lakes, territorial seas, and those waters connected directly to them, must be equipped with Coast Guard approved visual distress signals. These signals are either Pyrotechnic or Non-Pyrotechnic devices.

Pyrotechnic visual distress signals:

Pyrotechnic visual distress signals must be Coast Guard approved, in serviceable condition, and readily accessible. They are marked with a date showing the service life, which must not have expired. A minimum of three are required. Some pyrotechnic signals meet both day and night use requirements. They should be stored in a cool, dry location. They include:

- Pyrotechnic red flares, hand held or aerial.
- Pyrotechnic orange smoke, hand-held or floating
- Launchers for aerial red meteors or parachute flares

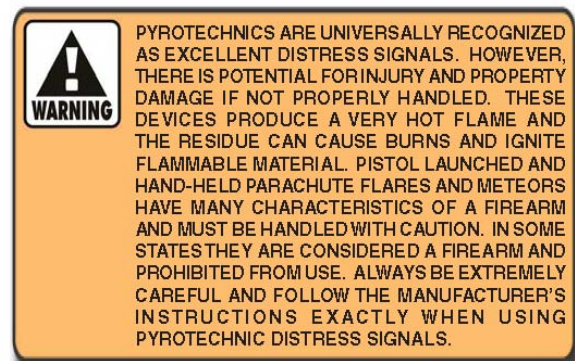

Non-Pyrotechnic Devices

Non-Pyrotechnic visual distress signals must be in serviceable condition, readily accessible, and certified by the manufacturer as complying with U.S. Coast Guard requirements. They include:

- **Orange Distress Flag (Day use only)**

The distress flag is a day signal only. It must be at least 3 x 3 feet with a black square and ball on an orange background. It is most distinctive when attached and waved from a paddle or boat hook.

- **Electric Distress Light (Night use only)**

The electric distress light is accepted for night use only and must automatically flash the international SOS distress signal. Under "Inland Navigation Rules", a high intensity white light flashing at regular intervals from 50-70 times per minute is considered a distress signal.

Sound Signaling Devices

The navigation rules require sound signals to be made under certain circumstances. Recreational vessels also are required to sound fog signals during periods of reduced visibility. Therefore, you must have some means of making an efficient sound signal.

Navigation Lights

Recreational boats are required to display navigation lights between sunset and sunrise and other periods of reduced visibility (fog, rain, haze, etc). Navigation lights are intended to keep other vessels informed of your presence and course. Your boat is equipped with navigation lights required by the U.S. Coast Guard at the time of manufacture. It is up to you to make sure they are operational and turned on when required.

9.3 First Aid

It is the operator's responsibility to be familiar with the proper first-aid procedures and be able to care for minor injuries or illnesses of your passengers. In an emergency, you could be far from professional medical assistance. We strongly recommend that you be prepared by receiving training in basic first aid and CPR. This can be done through classes given by the Red Cross or your local hospital.



Your boat also should be equipped with at least a simple marine first-aid kit and a first-aid manual. The marine first-aid kit should be designed for the marine environment and be well supplied. It should be accessible and each person on board should be aware of its location. As supplies are used, replace them promptly. Some common drugs and antiseptics may lose

their strength or become unstable as they age. Ask a medical professional about the supplies you should carry and the safe shelf life of prescription drugs or other medical supplies that may be in your first-aid kit. Replace questionably old supplies whether they have been used or not.

In many emergency situations, the Coast Guard can provide assistance in obtaining medical advice for treatment of serious injuries or illness. If you are within VHF range of a Coast Guard Station, make the initial contact on channel 16 and follow their instructions.

9.4 Additional Safety Equipment

Besides meeting the legal requirements, prudent boaters carry additional safety equipment. This is particularly important if you operate your boat offshore. You should consider the following items, depending on how you use your boat.

Satellite EPIRBs

EPIRBs (Emergency position Indicating Radio Beacon) operate as part of a worldwide distress system. When activated, EPIRBs will send distress code homing beacons that allow Coast Guard aircraft to identify and find them quickly. The satellites that receive and relay EPIRB signals are operated by the National Oceanic and Atmospheric Administration (NOAA) in the United States. The EPIRB should be mounted and registered according to the instructions provided with the beacon, so that the beacon's unique distress code can be used to quickly identify the boat and owner.

Marine Radio

A marine radio is the most effective method of receiving information and requesting assistance. VHF marine radios are used near shore and single sideband radios are used for long range communication.

There are specific frequencies to use in an emergency. The VHF emergency channel is 16 in the United States. You should read the owners manual for your radio and know how to use it in an emergency or for normal operation. If you hear a distress call you should assist or monitor the situation until help is provided.

Additional Equipment to Consider:

VHF Radio	Life Raft
Spare Anchor	Fenders
Heaving Line	Mirror
First Aid Kit	Tool Kit
Flashlight & Batteries	Anchor
Searchlight	Boat Hook
Sunburn Lotion	Mooring Lines
Ring Buoy	Binoculars
Whistle or Horn	Extra Clothing
Portable radio	Chart and Compass
Marine Hardware	Food & Water
Spare Keys	Sunglasses
Spare Parts	Spare Propeller

210 COASTAL SAFETY LABELS



2601-1124



2601-1094

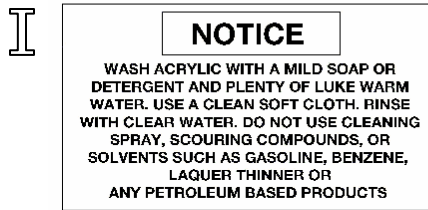

2601-2368

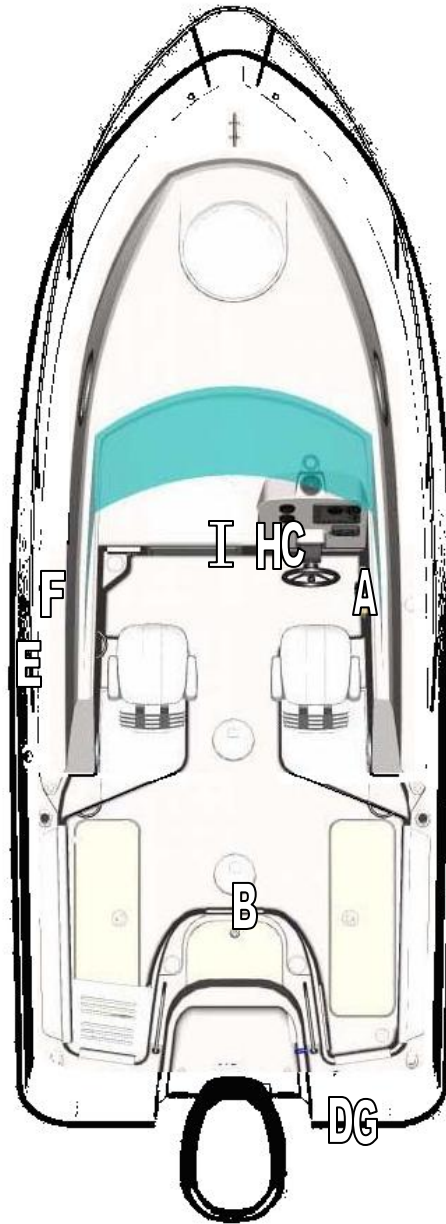

A



B



2601-1850

C



2601-1744

D

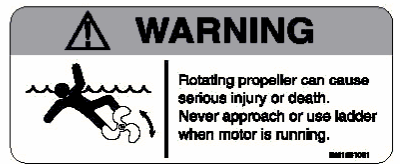

2601-1752

E

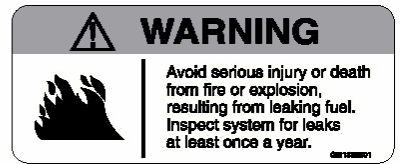

2601-1710

F

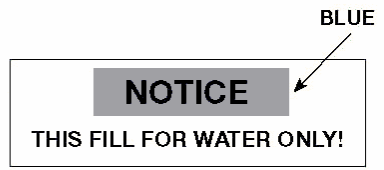

2601-4522

Chapter 10: OPERATION

10.1 General

Before you start the engines on your Wellcraft, you should have become familiar with the various component systems and their operation, and have performed a "Pre-cruise System Check." A thorough understanding of the component systems and their operation is essential to the proper operation of the boat. This manual and the associated manufacturers' information is provided to enhance your knowledge of your boat. Please read them carefully.

Your boat must have the necessary safety equipment on board and be in compliance with the U.S. Coast Guard, local and state safety regulations. There should be one Personal Floatation Device (PFD) for each person. Non-swimmers and small children should wear a PFD at all times. You should know and understand the "Rules of the Road" and have had an experienced operator brief you on the general operation of your new boat. At least one other person should be instructed on the proper operation of the boat in case the operator is suddenly incapacitated.

The operator is responsible for his safety and the safety of his or her passengers. When boarding or loading the boat, always step onto the boat, never jump. All passengers should be properly seated whenever the boat is operated above idle speed. Your passengers should not be allowed to sit on the seat backs, gunnels, bows, transoms or on fishing seats whenever the boat is underway. The passengers also should be seated to properly balance the load and must not obstruct the operator's view, particularly to the front.

Overloading and improper distribution of weight can cause the boat to become unstable and are significant causes of accidents. Know the weight capacity and horsepower rating of your boat. Do not overload or overpower your boat.

You should be aware of your limitations and the limitations of your boat in different situations or sea conditions. No boat is indestructible, no matter how well it is constructed. Any boat can be severely damaged if it is operated in a manner that exceeds its design limitations. If the ride is hard on you and your passengers, it is hard on the boat as well. Always modify the boat speed in accordance with the sea conditions, boat traffic and weather conditions.

Remember, it is the operator's responsibility to use good common sense and sound judgment in loading and operating the boat.

10.2 Rules of the Road

As in driving an automobile, there are a few rules you must know for safe boating operation. The following information describes the basic navigation rules and action to be taken by vessels in a crossing, meeting or overtaking situations while operating in inland waters. These are basic examples and not intended to teach all the rules of navigation. For further information consult the "Navigation Rules" or contact the Coast Guard, Coast Guard Auxiliary, Department of Natural Resources, or your local boat club. These organizations sponsor courses in boat handling, including rules of the road. We strongly recommend such courses. Books or videos on this subject also are available from your local library.

Note: Sailboats not under power, paddle boats, vessels unable to maneuver, vessels engaged in commercial fishing and other vessels without power have the right of way over motor powered boats. You must stay clear or pass to the stern of these vessels. Sailboats under power are considered motor boats.

Crossing Situations

When two motor boats are crossing, the boat on the right has the right of way. The boat with the right of way should maintain its course and speed. The other vessel should slow down and permit it to pass. The boats should sound the appropriate signals.

Meeting Head-On or Nearly-So Situations

When two motor boats are approaching each other head-on or nearly head-on, neither boat has the right of way. Both boats should reduce their speed and turn to the right so as to pass port side to port side, providing enough clearance for safe passage. The boats should sound the appropriate signals.

Overtaking Situations

When one motor boat is overtaking another motor boat, the boat that is being passed has the right of way. The overtaking boat must make the adjustments necessary

to provide clearance for a safe passage of the other vessel. The boats should sound the appropriate signals.

The General Prudential Rule

In obeying the Rules of the Road, due regard must be given to all dangers of navigation and collision, and to any special circumstances, including the limitations of the vessels, which may justify a departure from the rules that is necessary to avoid immediate danger or a collision.

Night Operation

Recreational boats are required to display navigation lights between sunset and sunrise and other periods of reduced visibility such as fog, rain, haze, etc. When operating your boat at night you should:

- Make sure your navigation lights are on and working properly. Navigation lights warn others of your position and course and the position and course of other vessels.
- All navigation rules apply. If the bow light of another vessel shows red, you should give way to that vessel, if it shows green, you have the right of way.
- Slow down and never operate at high speeds when operating at night, stay clear of all boats and use good common sense. Always be ready to slow down or steer clear of other vessels, even if you have the right-of-way.
- Avoid bright lights that can destroy night vision, making it difficult to see navigation lights and the lights of other boats. You and your passengers should keep a sharp lookout for hazards, other boats and navigational aids.

Navigation Aids

Aids to navigation are placed along coasts and navigable waters as guides to mark safe water and to assist mariners in determining their position in relation to land and hidden dangers. Each aid to navigation is used to provide specific information. You should be familiar with these and any other markers used in your boating area.

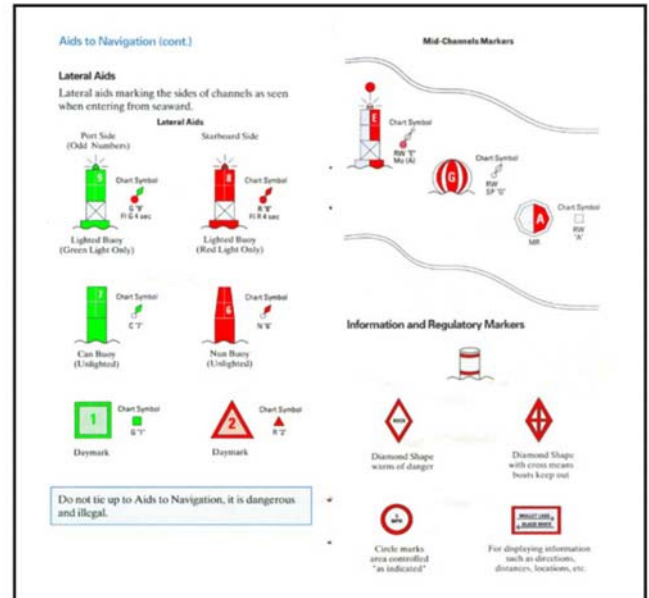

Channel Markers and Buoys

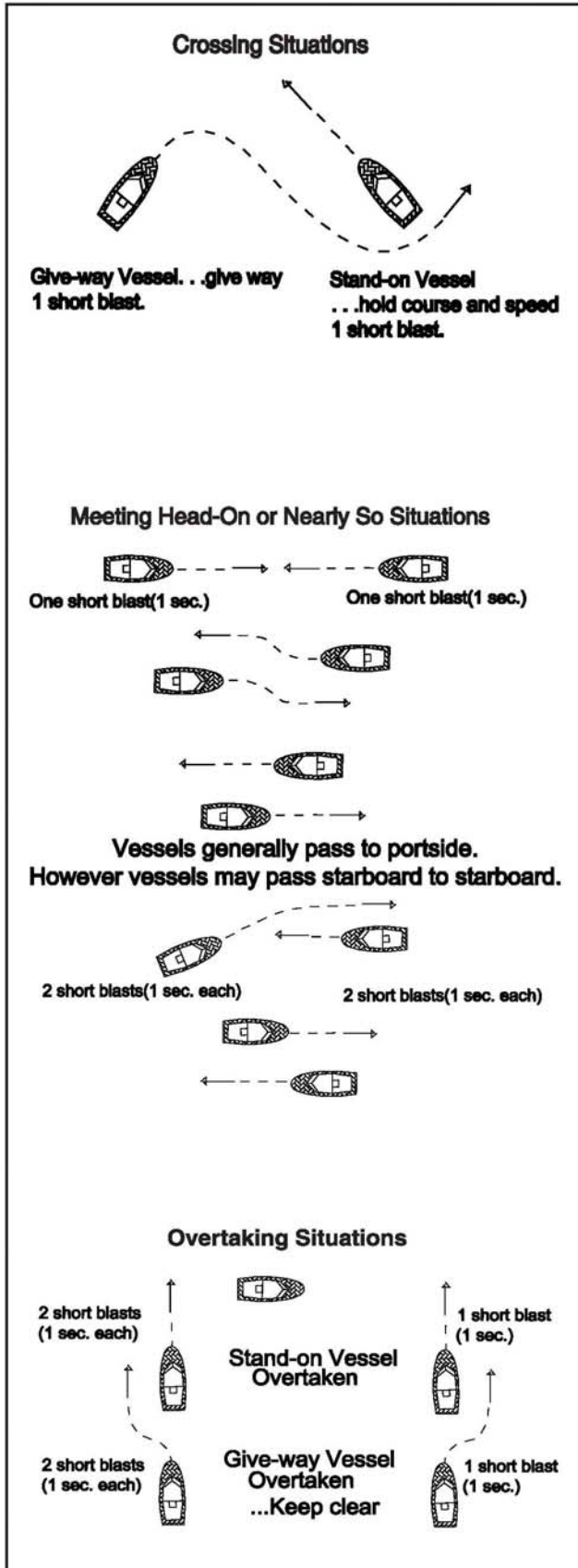

Note: Storms and wave action can cause buoys to move. You should not rely on buoys alone to determine your position.

10.3 Pre-Cruise Check **Before Starting the Engines:**

- Check the weather forecast and sea conditions before leaving the dock. Decide if the planned cruise can be made safely.
- Be sure all required documents are on board.
- Be sure all necessary safety equipment is on board and operative. This should include items like the running lights, spotlight, life saving devices, etc. Please refer to Safety Equipment chapter for additional information on safety equipment.
- Make sure you have signal kits and flare guns aboard, and they are current and in good operating condition.
- Be sure you have sufficient water and other provisions for the planned cruise.
- Leave a written message listing details of your planned cruise with a close friend ashore (Float Plan). The float plan should include a description of your boat, where you intend to cruise, and a schedule of when you expect to arrive in the cruising area, and when you expect to return. Keep the person informed of any changes in your plan to prevent false alarms. This information will tell authorities where to look and the type of boat to look for in the event you fail to arrive.
- Check the amount of fuel on board. Observe the "rule of thirds": one third of the fuel for the trip out, one third to return and one third in reserve. An additional 15% may be consumed in rough seas.
- Check the water separating fuel filters for water. The engine fuel filters also should be checked for leaks or corrosion.
- Turn the battery switches on.
- Check the bilge water level. Look for other signs of potential problems. Monitor for the scent of fuel fumes.
- Test the automatic and manual bilge pump switches and high water alarm switches to make sure the systems are working properly. This is particularly important before running offshore.

- Have a tool kit aboard. The kit should include the following basic tools:

Hammer	Electrician's tape
Screwdrivers	Offset screwdrivers
Lubricating oil	Pliers
Jackknife	Adjustable wrench
Basic 3/8" ratchet set	Vise grip pliers
Hex key set	Needle nose pliers
Wire crimping tool	Wire connector Set
End wrench set	Medium slip-joint pliers
Diagonal cutting pliers	DC electrical test light

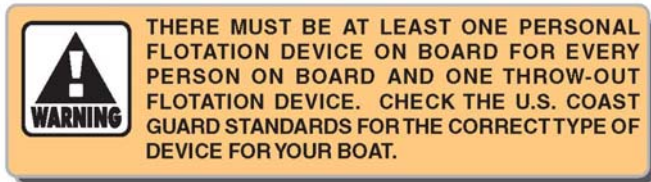

- Have the following spare parts on board:

Extra light bulbs	Spark plugs
Fuses and circuit breakers	Main 12-volt fuses
Assorted stainless screws	Assorted stainless bolts
Flashlight and batteries	Drain plugs
Engine oil and transmission oil	Propellers
Fuel filters	Propeller nuts
Fuel hose and clamps	Wire ties
Engine cooling pump impeller	Hydraulic steering oil
Assorted hose clamps	Rags
Steering fluid	Pump & alternator belts

- Make sure all fire extinguishers are in position and in good operating condition.

10.4 Operating Your Boat

After Starting the Engines:

- Check the engine gauges. Make sure they are reading normally.
- Visibly check the engines to be sure there are no apparent water, fuel or oil leaks.
- Check the operation of the engine cooling systems by inspecting the transom exhaust ports for water flow.
- Check the steering and engine controls for proper operation.
- Make sure all lines, cables, anchors, etc. for securing a boat are on board and in good condition. All lines should be coiled, secured and off the decks when underway.

- Have a safe cruise and enjoy yourself.

Remember:

When you operate a boat, you accept the responsibility for the boat, for the safety of passengers and for others out enjoying the water.

- Alcohol and any drugs can severely reduce your reaction time and affect your better judgment.
- Alcohol severely reduces the ability to react to several different signals at once.
- Alcohol makes it difficult to correctly judge speed and distance, or track moving objects.
- Alcohol reduces night vision, and the ability to distinguish red from green.

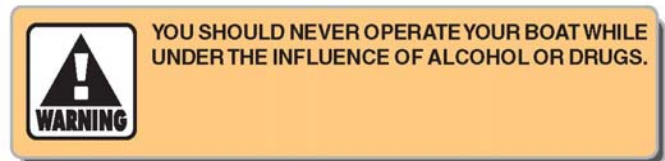

- Make sure one other person on the boat is instructed in the operation of the boat.
- Make sure the boat is operated in compliance with all state and local laws governing the use of a boat.

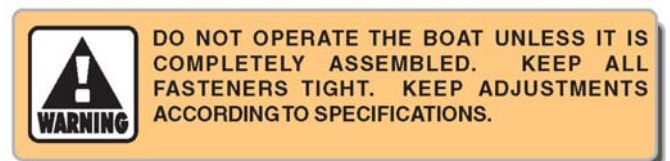

- Always operate the blowers when operating the boat below cruising speed or when the generator is running to help cool the engine compartment.
- Avoid sea conditions that are beyond the skill and experience of you and your crew. Learn to understand weather patterns and indications for change. You should monitor NOAA weather broadcasts before leaving port and periodically while boating. If the weather deteriorates or a storm approaches, seek shelter in a safe harbor.
- Use caution during periods of reduced visibility due to weather or operation conditions. Reduce speed and designate a passenger to be a lookout for other boats, obstacles and navigational markers until you reach port or conditions improve.

- Your Wellcraft is a heavy boat that will produce a large wake at certain speeds. You are responsible for damage and injury caused by your boat's wake. Always observe no wake zones and be aware that your wake can endanger small vessels and their passengers. Always be courteous and slow down to reduce your wake when passing smaller boats.
- Before operating the boat for the first time, read the engine break-in procedures. The break-in procedures are found in the owner's manual for the engines. The manual is in the literature packet.
- As different types of engines are used to power the boat, have the dealer describe the operating procedures for your boat. For more instructions on "How To Operate The Boat," make sure you read the instructions given to you in the owner's manual for the engines you have selected.

Note: For more instructions on safety, equipment and boat handling, enroll in one of the several free boating courses offered. For information on the courses offered in your area, call the "Boating Course Hotline," 1-800-368-5647 or on the WEB at www.uscgboating.org.

Note: If the running gear hits an underwater object, stop the engines. Inspect the propulsion system for damage. If the system is damaged, contact your dealer for a complete inspection and repair of the unit.

To stop the boat, follow this procedure:

- Allow the engines to drop to the idle speed.
- Make sure the shifting levers are in the neutral position.

Note: If the engines have been run at high speed for a long period of time, allow the engines to cool down by running the engines in the idle position for 3 to 5 minutes.

- Turn the ignition keys to the "OFF" position.
- Raise the trim tabs to the full up position.

After Operation:

- If operating in saltwater, wash the boat and all equipment with soap and water.

- Check the bilge area for debris and excess water.
- Fill the fuel tank to near full to reduce condensation. Allow enough room in the tank for the fuel to expand without being forced out through the vent.
- Turn off all electrical equipment except the automatic bilge pumps.
- If you are going to leave the boat for a long period of time, put the battery main switches in the "OFF" position and close all seacocks.
- Make sure the boat is securely moored.



10.5 Docking, Anchoring and Mooring

Docking and Dock Lines

Maneuvering the boat near the dock and securing the boat require skill and techniques that are unique to the water and wind conditions and the layout of the dock. If possible, position a crew member at the bow and stern to man the lines and assist in docking operations. While maneuvering close to the dock consideration must be given to the wind and current. You should anticipate the effect these forces will have on the boat and use them to help put the boat where you want it. It is important to practice in open water using an imaginary dock enough to develop a sense for the way your boat handles in a variety of docking scenarios. You must be able to foresee the possibilities and have solutions in mind before problems occur.

Approaching a dock or backing into a slip in high winds or strong currents requires a considerable amount of skill. If you are new to boat handling, you should take lessons from an experienced pilot to learn how to maneuver your boat in tight quarters in less than ideal conditions. You should also practice away from the dock during windy conditions. Dock lines are generally twisted or braided nylon. Nylon is strong and stretches to absorb shock. It also has a long life and is soft and easy on the hands. The line's size will vary with the size of the boat. Typically a 30 to 40 foot boat will use 5/8-inch line and a 20 to 30 foot boat will use 1/2-inch line. The number of lines and their configuration will vary depending on the dock, the range of the tide, and many other factors. Usually a combination of bow, stern and spring lines is used to secure the boat.

Maneuvering to the Dock

Approach the dock slowly at a 30 to 40 degree angle. Whenever possible, approach against the wind or current. Turn the engine straight & shift to neutral when you feel you have enough momentum to reach the dock. Use reverse to slow the boat and pull the stern toward the dock as the boat approaches. Use the engine(s) to stop the boat if it is still moving forward against the pilings. If you executed your approach properly, the boat will lightly touch the pilings at the same time the forward momentum is stopped. Have the dock lines ready and secure the boat as soon as it stops. Use fenders to protect the boat while it is docked. Keep the engine(s) running until the lines are secured.

Backing into a Slip

Approach the slip with the stern against the wind or current and the engine straight ahead. Use the engine(s) to maneuver the boat into alignment with the slip. Reverse the engine(s) and slowly back into the slip. Shift from reverse to neutral frequently to prevent the boat from gaining too much speed. Move the stern right and left by shifting the engine(s) in and out of gear. When nearly in the slip all the way, shift to forward to stop. Keep the engines running until the lines are secured.

Securing Dock Lines

Securing a boat that is tied along side the dock typically requires a bow and stern line and two spring lines. The bow and stern lines are usually secured to the dock at a 40° angle aft of the stern cleat and forward of the bow cleat. The after bow spring line is secured to the dock at a 40° angle aft of the after bow spring cleat. The forward quarter spring is secured to the dock at a 40° angle forward of the stern cleat. The spring lines keep the boat square to the dock and reduce fore and aft movement while allowing the boat to move up and down with the tide.

Securing a boat that in a slip is somewhat different. It typically requires two bow lines secured to pilings on each side of the bow, two stern lines secured to the dock and two spring lines that prevent the boat from hitting the dock. The bow lines are typically secured with enough slack to allow the boat to ride the tide. The stern lines are crossed. One line runs from the port aft boat cleat to the starboard dock cleat and the other line runs from the starboard aft boat cleat to the port cleat on the dock. The stern lines center the boat, control the forward motion, and allow the boat to ride the tide. Two forward quarter spring lines typically are secured to the stern cleats and to mid ship pilings or cleats. The spring lines keep the boat from backing into the dock while allowing it to ride the tide.

Leaving the Dock

Always start the engine(s) and let them warm up for several minutes before releasing the lines. Boats steer from the stern and it is important that you achieve enough clearance at the stern to maneuver the boat as quickly as possible. Push the stern off and maneuver such that you get stern clearance quickly. Proceed slowly until well clear of the dock and other boats.

Mooring

Approach the mooring heading into the wind or current. Shift to neutral when you have just enough headway to reach the buoy. Position a crew member on the bow to retrieve the mooring with a boat hook and secure the line. Keep the engine(s) running until the line is secured.

Leaving a Mooring

Start the engine(s) and let them warm up for several minutes before releasing the mooring line. The boat will already be headed into the wind, so move it forward enough to loosen the line and untie it. Back the boat away from the mooring until you can see the buoy. Move the boat slowly away from the mooring.

Anchoring

Make sure the bitter end of the anchor line is attached to boat before dropping the anchor. Bring the bow into the

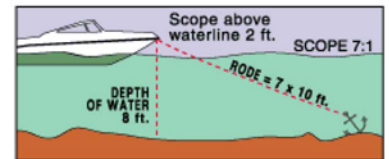

the engine in neutral. When the vessel comes to a stop, lower the anchor over the bow. Pay out anchor line so that it is at least 5 to 7 times the depth of the water and secure the line to a cleat. Use caution to avoid getting your feet or hands tangled in the line. Additional scope of 10 times the depth may be required for storm conditions. Check landmarks on shore or your GPS position to make sure the anchor is not dragging. If it is dragging, you will have to start all over. It is prudent to use two anchors if your are anchoring overnight or in rough weather.

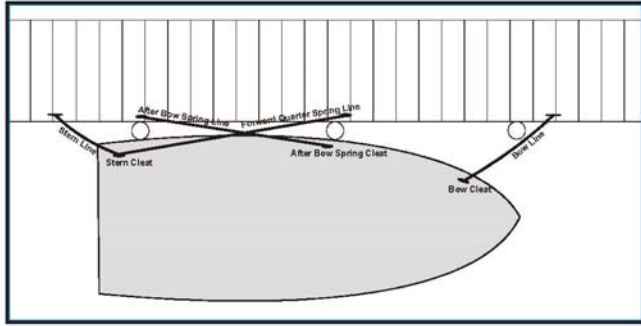

Securing The Boat Along Side A Dock (Typical)

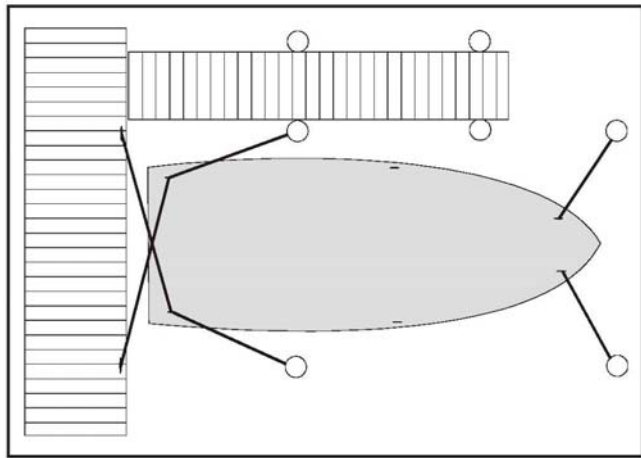

Securing The Boat In A Slip (Typical)

Releasing the Anchor

Release the anchor by driving the boat slowly to the point where the anchor line becomes vertical. It should release when you pass that point. If the anchor doesn't release right away, stop the boat directly above the anchor and tie the line to the cleat as tight as possible. The up and down movement of the boat will usually loosen the anchor within a minute. Make sure you secure the anchor and properly stow the line before operating the boat.

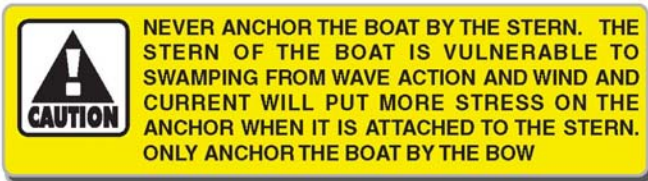

10.6 Controls, Steering, or Propulsion System Failure:

If the propulsion, control or steering system fails while you are operating the boat, bring both throttles to idle and shift to neutral. Decide whether you need to put out the anchor to prevent the boat from drifting or to hold the bow into the seas. Investigate and correct the problem if you can. Turn the engine(s) off before going into the engine compartment to make repairs. If you are unable to correct the problem, call for help.

If only one engine has failed, you can usually run home on the other engine. Be careful not to apply too much power to the engine that is running. When only one engine is used to power a twin engine boat, that engine is over propped and can be overloaded if too much throttle is applied. You should contact your dealer or the engine manufacturer for the maximum power settings when running on one engine.

10.7 Collision

If your boat is involved in a collision with another boat, dock, piling or a sandbar, your first priority is to check your passengers for injuries and administer first aid if necessary. Once your passengers situations are stabilized, thoroughly inspect the boat for damage. Check below decks for leaks and the control systems for proper operation. Plug all leaks or make the necessary repairs to the control systems before proceeding slowly and carefully to port. Request assistance if necessary. Haul the boat and make a thorough inspection of the hull and running gear for damage.

10.8 Grounding, Towing and Rendering Assistance

The law requires the owner or operator of a vessel to render assistance to any individual or vessel in distress, as long as his vessel is not endangered in the process.

If the boat should become disabled, or if another craft that is disabled requires assistance, great care must be taken. The stress applied to a boat during towing may become excessive. Excessive stress can damage the structure of the boat and create a safety hazard for those aboard.

Freeing a grounded vessel, or towing a boat that is disabled, requires specialized equipment and knowledge. Line failure and structural damage caused by improper towing have resulted in fatal injuries. Because of this, we strongly suggest that these activities be left to those who have the equipment and knowledge, e.g., the U.S. Coast Guard or a commercial towing company, to safely accomplish the towing task.

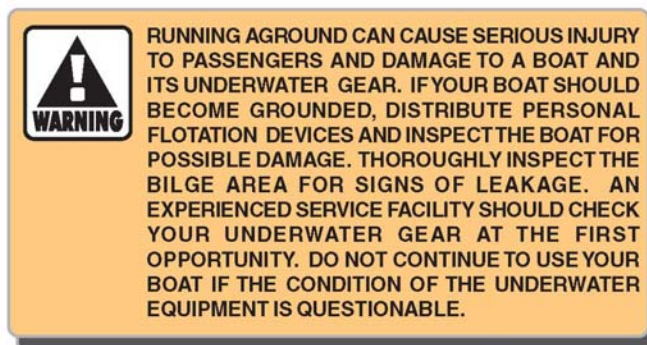
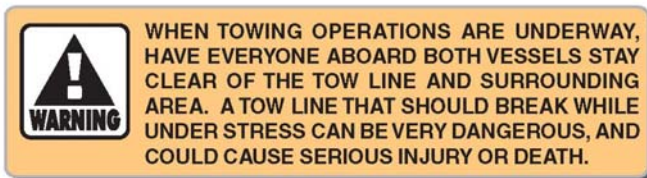
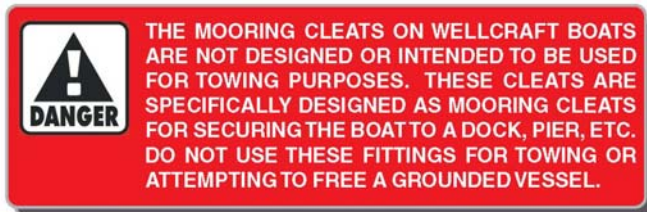

10.9 Flooding, or Capsizing

Boats can become unstable if they become flooded or completely swamped. You must always be aware of the position of the boat to the seas and the amount of water in the bilge. Water entering the boat through the transom door or over the stern gunnels can usually be corrected by closing the door and turning the boat into the waves. If the bilge is flooding because of a hole in the hull or a defective hose, you may be able to plug it with rags, close the thru-hull valve or assist the pumps by bailing with buckets. Put a mayday call in to the Coast Guard or nearby boats and distribute life jackets as soon as you discover your boat is in trouble.

If the boat becomes swamped and capsizes, you and your passengers should stay with the boat as long as you can. It is much easier for the Coast Guard, aircraft, or other boats to spot, than people in the water. If your boat is equipped with an EPIRB, make sure it is activated. When activated, EPIRBs will send distress code homing beacons that allow Coast Guard aircraft to identify your boat and find you quickly.

10.10 Fishing

Fishing can be very exciting and distracting for the operator when the action gets intense. You must always be conscious of the fact that your primary responsibility is the safe operation of your boat and the safety of your passengers and other boats in the area.

You must always make sure the helm is properly manned and is never left unattended while trolling.

If you are fishing in an area that is crowded with other fishing boats, it may be difficult to follow the rules of the road. This situation can become especially difficult when most boats are trolling. Being courteous and exercising good common sense is essential. Avoid trying to assert your right of way and concentrate on staying clear and preventing tangled or cut lines and other unpleasant encounters with other boats.

10.11 Man Overboard

If someone falls overboard, you must be prepared to react quickly, particularly when you are offshore. The following procedures will help you in recovering a person that has fallen overboard.

- Immediately stop the boat and sound a man overboard alarm and have all passengers point to the person in the water.
- Circle around quickly and throw a cushion or life jacket to the person, if possible, and another to use as a marker.
- Keep the person on the driver side of the boat so you can keep him in sight at all times.
- Make sure to approach the person from the downwind side and maneuver the boat so the propellers are well clear of the person in the water.
- Turn off the engine(s) when the person is alongside and use a ring buoy with a line attached, a paddle or boat hook to assist him to the boat. Make sure you don't hit him with the ring buoy or the boat.
- Pull the person to the boat and assist him on board.
- Check the person for injuries and administer first aid if necessary. If the injuries are serious, call for help. Refer to the Safety chapter for more information on first aid and requesting emergency medical assistance.

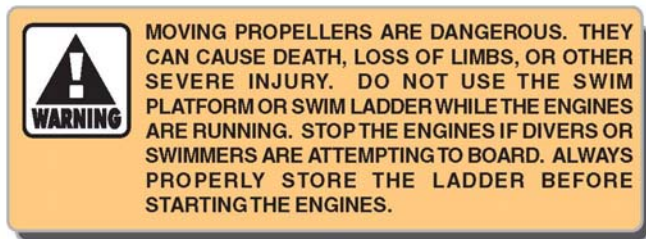

10.12 Trash Disposal

The discharge of plastic trash or trash mixed with plastic is illegal anywhere in the marine environment. U.S. Coast Guard regulations also restrict the dumping of other forms of garbage. Regional, State, and local restrictions on garbage discharges also may apply.

Responsible boaters store refuse in bags and dispose of it properly on shore. You should make sure your passengers are aware of the local waste laws and the trash management procedure on your boat. Refer to the placard mounted on your boat for more specific information regarding solid waste disposal.

10.13 Trailering Your Boat

If you trailer your boat, make sure your tow vehicle is capable of towing the weight of the trailer, boat and equipment and the weight of the passengers and equipment inside the vehicle. This may require that the tow vehicle be specially equipped with a larger engine, transmission, brakes and trailer tow package.

The boat trailer is an important part of your boating package. The trailer should be matched to your boat's weight and hull. Using a trailer with a capacity too low will be unsafe on the road and cause abnormal wear. A trailer with a capacity too high, your towing vehicle and hitch, and to make sure you have the correct trailer for your boat.

Note: Contact your trailer dealer to evaluate your towing vehicle and hitch, and to make sure you have the correct trailer for your boat.

- Make sure the trailer is a match for your boat's weight and hull design. More damage can be done to a boat by the stresses of road travel than by normal water operation. A boat hull is designed to be supported evenly by the water. So, when it is transported on a trailer it should be supported structurally as evenly across the hull as possible allowing for even distribution of the weight of the hull, engine(s) and equipment.

- Make sure the trailer bunks and /or rollers properly support the hull and do not put pressure on the lifting strakes. The rollers and bunks must be kept in good condition to prevent scratching and gouging of the hull.
- The capacity rating of the trailer should be greater than the combined weight of the boat, motor, and equipment. The gross vehicle weight rating must be shown on the trailer. Make sure the weight of the boat, engine, gear, and trailer is not more than the gross vehicle weight rating.
- Make sure the boat is securely fastened on the trailer to prevent movement between the boat and trailer. The bow eye on the boat should be secured with rope, chain or turnbuckle in addition to the winch cable. Additional straps may be required across the beam of the boat or from the transom eyes to the trailer.

Note: Your trailer dealer will give instructions on how to load, fasten and launch your boat.

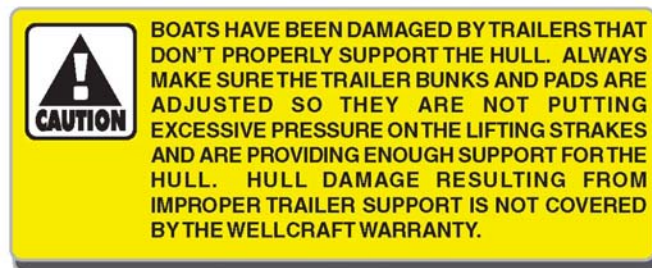

Before Going Out On The Highway:

- T-TOP ENCLOSURE must be removed when trailering. Canvas enclosures are not designed to withstand the extreme wind pressure encountered while trailering and will be damaged. Always remove and properly store the enclosure before trailering your boat.
- Make sure the tow BALL and TRAILER COUPLER are the same size and bolts and nuts are tightly secured.
- The COUPLER MUST BE COMPLETELY OVER THE BALL and the LATCHING MECHANISM LOCKED DOWN.
- Make sure the TRAILER IS LOADED EVENLY from front to rear as well as side to side and has the correct weight on the hitch. Too much weight on the hitch will cause the rear of the tow vehicle to drag and may make steering more difficult. Too little weight on the hitch will cause the rig to fishtail and

will make controlling the tow vehicle difficult. Contact your local trailer manufacturer or dealer for the correct weight on the hitch for your trailer.

- The SAFETY CHAINS must be attached crisscrossing under the coupler to the frame of the tow vehicle. If the ball was to break, the trailer would follow in a straight line and prevent the coupler from dragging on the road. Make sure the trailer emergency brake cable or chain is also installed to the tow vehicle frame.
- Make sure the LIGHTS on the trailer function properly.
- CHECK THE BRAKES. On a level parking area roll forward and apply the brakes several times at increasing speeds to determine if the brakes on the tow vehicle and trailer are working properly.
- Make sure the tow vehicle has SIDE VIEW MIRRORS that are large enough to provide an unobstructed rear view on both sides of the vehicle.
- CHECK THE TIRES and WHEEL BEARINGS.

Note: Make sure your towing vehicle and trailer are in compliance with all state and local laws. Contact your state motor vehicle bureau for laws governing the towing of trailers.

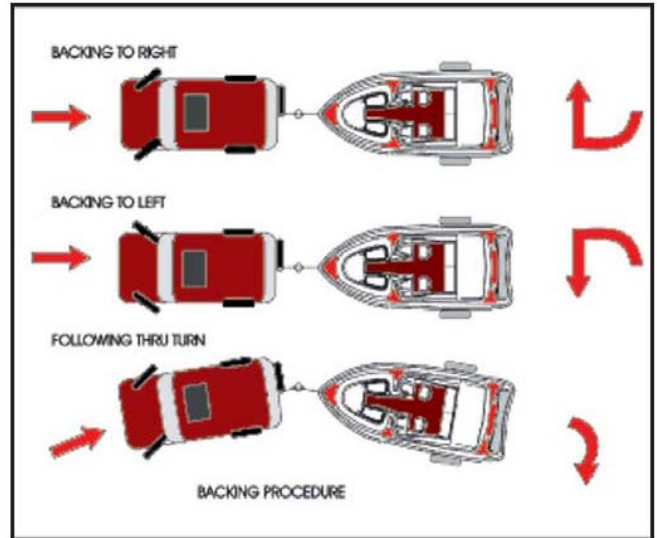

Chapter 11:

ROUTINE MAINTENANCE

11.1 Exterior Hull and Deck

Hull Cleaning-Below The Water Line

When the boat is removed from the water, clean the outer bottom surface immediately. Algae, grass, dirt, and other marine growth are easier to remove while the hull is still wet. Use a pressure cleaner or a hard bristle brush to clean the surface.

Bottom Painting

If the boat is to be left in the water for extended periods, the hull must be protected from marine growth by antifouling paint. Because of variations in water temperature, marine growth, and pollution in different regions, your dealer and/or a qualified boat yard in your area should be consulted when deciding what bottom paint system to apply to your hull. This is extremely important as pollution and marine growth can damage fiberglass hulls.

Do not allow the hull antifouling paint to contact the outboard motor. Most antifouling paints designed for hull bottoms contain copper and can cause severe galvanic corrosion damage to the motor. Always leave a ½" barrier between the hull bottom paint and outboard motor.

Osmosis blistering is caused by a chemical reaction between water and substances in the hull laminate below the waterline. If water breaches the exterior gelcoat and barrier layer, it can react with the chemical components in the laminate creating acidic substances. These substances create pressure behind the gelcoat which cause blisters. An epoxy barrier coating such as the Interlux Interprotect® system properly applied to the hull before bottom paint will help prevent this problem. A barrier coating also provides an excellent base coat for the bottom paint.

Even though the hull on your Wellcraft is built with a layer of blister resistant resin, we recommend that additional protection from marine growth and pollution be provided by a barrier coating system and antifouling paint if the boat is to be left in the water for over two weeks. This is extremely important as pollution and marine growth can cause osmosis and damage fiberglass hulls.

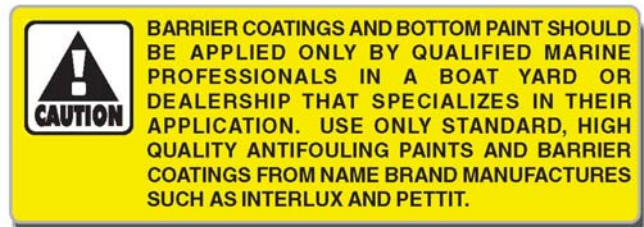
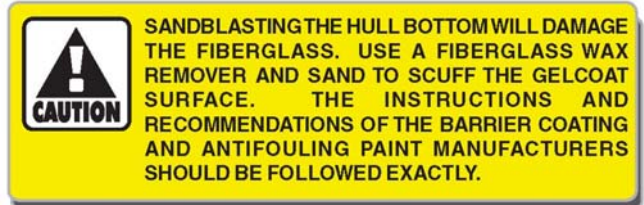

Most bottom paints require some maintenance. Proper maintenance is especially important when the boat is in saltwater and not used for extended periods or after dry storage. If the hull bottom has been painted with antifouling paint, contact your dealer for the recommended maintenance procedures.

Sacrificial Anodes

Sacrificial anodes are installed on the outboard motor. Anodes should also be installed on the trim tabs if the boat is kept in the water. Anodes should be checked monthly and changed when they are 50-75% of their original size. When replacing the anodes, make sure the contact surfaces are clean, shiny metal and free of paint and corrosion. Never paint over the anode.

Boats stored in salt water will normally need to have the anodes replaced every six months to one year. Anodes requiring replacement more frequently may indicate a stray current problem within the boat at the slip or marina. Anodes that do not need to be replaced after one year may not be providing the proper protection. Loose or low quality anodes could be the problem. Contact your dealer for the proper size and type of zinc anodes to be used and the specific installation procedure.

There are at least two anodes on most outboard engines. There is a large anode on the bottom of the clamp bracket and another anode on the anti-cavitation plate, above the propeller.

Fiberglass Gelcoat Surfaces

Normal maintenance requires only washing with mild soap and water. A stiff brush can be used on the nonskid areas. Kerosene or commercially prepared products will remove oil and tar which could be a problem on trailered boats. Harsh abrasive and chemical cleaners are not recommended because they can damage or dull the gelcoat, reducing its life and making it more susceptible to stains. When the boat is used in saltwater, it should be washed thoroughly with soap and water after each use.

At least once a season, wash and wax all exposed fiberglass surfaces. Use a high quality automotive or boat wax. Follow the procedure recommended by the wax manufacturer. The washing and waxing of your boat will have the same beneficial effects as they have on an automobile finish. The wax will fill minute scratches and pores thus helping to prevent soiling and will extend the life of the gelcoat.

After the boat is exposed to the direct sunlight for a period of time, the color in the gelcoat tends to fade, dull or chalk. A heavier buffing is required to bring the gelcoat back to its original luster. For power cleaning use a light cleaner. To clean the boat by hand, use a heavier automotive cleaner. Before cleaning the surfaces, read the instructions given with the cleaner. After cleaning the surfaces, apply wax and polish all fiberglass surfaces except the nonskid areas.

If the fiberglass should become damaged and need repair, contact your dealer for an authorized repair person to make the repairs.

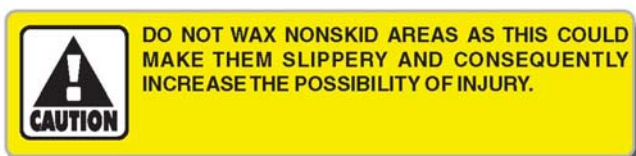

Stainless Steel Hardware

When using the boat in saltwater, the hardware should be washed with soap and water after each use. When a boat is used in a corrosive environment such as saltwater, water with a high sulfur content, or polluted water, the stainless steel will periodically develop surface rust stains. This is perfectly normal under these conditions. The stainless can normally be cleaned and protected by using a high quality boat or automotive wax or a commercial metal cleaner and protectant.

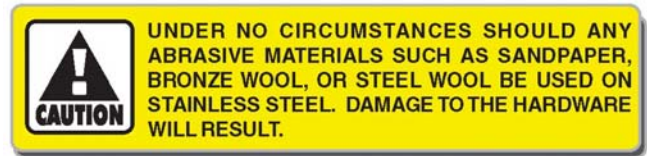

Anodized Aluminum Surfaces

Anodized aluminum should be washed periodically with soap and water to keep it clean. If the boat is used in saltwater or polluted water, the aluminum should be washed with soap and water after each use. Saltwater allowed to remain on anodized aluminum will penetrate the anodized coating and attack the aluminum.

Hard Tops with anodized aluminum frames, bimini tops with canvas and/or fiberglass tops require special attention to the anodized aluminum just below the top. This area is subject to salt build up from salty condensation and sea spray. It is also frequently overlooked when the boat is washed and will not be rinsed by the rain. Consequently, the aluminum just below the top is more likely to become pitted than the exposed aluminum on the structure. Make sure the aluminum in this area is washed frequently with soap and water and rinsed thoroughly. Pay particular attention to places where the top material contacts the frame. Once a month, coat the entire frame with a metal protector made for anodized aluminum to protect against pitting and corrosion caused by the harsh effects of salt water.

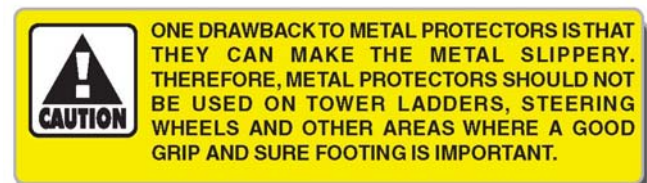

Stains can be removed anodized aluminum with a metal polish or fine polishing compound. To minimize corrosion, use a caulking compound or teflon based sealer to bed hardware and fasteners mounted to aluminum fabrications. If the anodized coating is badly scratched it can be touched up with paint. With proper care, anodized aluminum will provide many years of service.

Powder Coated Aluminum

Powder coated aluminum should be washed periodically with soap and water to keep it clean. If the boat is used in saltwater or polluted water, the aluminum should be washed with soap and water after each use. Saltwater allowed to remain on powder coated aluminum will penetrate the coating and attack the aluminum, usually around fasteners and hardware mounted to the aluminum.

Pay special attention to the area just below the top on powder coated frames. This area is subject to salt build up from salty condensation and sea spray. It is also frequently overlooked when the boat is washed and will not be rinsed by the rain. Consequently, the powder coating near fasteners and hardware mounted just below the top is more likely to be attacked by the salt and become corroded than the exposed areas on the structure. Make sure the aluminum in this area is washed frequently with soap and water and rinsed thoroughly. Pay particular attention to places where the top material contacts the frame.

Once a month check the entire frame for damaged powder coating and corrosion around fasteners and hardware. Nicked or badly scratched powder coating can be sanded and touched up with enamel paint. Corrosion around fasteners will have to be sanded, then touched up with paint. The fasteners will require fiber washers and sealing with caulk or a teflon based sealer to isolate the fastener from the aluminum and prevent damage to the paint or powder coating when the fastener is installed. Periodically applying automotive or boat wax to the powder coating will provide additional protection from the harsh effects of saltwater.

Always repair scratches, nicks and corroded areas in powder coating as soon as possible. Corrosion left unaddressed will lift the powder coating allowing moisture to travel between the powder coating and the aluminum causing the corrosion to spread below the coating and damage the aluminum.

If excessive chipping and peeling occurs, it could be an indication of an electrical fault in the boat or aluminum fabrication. You should contact a qualified marine electrician to inspect your boat immediately and correct the problem if you suspect that your boat may have a fault in the aluminum frame. You should also contact Wellcraft Customer Service.

Note: Boats that are towed behind larger vessels require special attention to the aluminum hardware. The salt spray, salty steam, and chemicals in exhaust gases are particularly corrosive and will eventually penetrate and damage the surface of anodized or powder coated aluminum. It is imperative that the boat and the aluminum are cleaned thoroughly at the completion of each trip or at the end of each day on long cruises to reduce accelerated deterioration of the anodizing or powder coating and premature corrosion to the aluminum.

Note: You should contact Wellcraft Customer Service before making any modifications to aluminum fabrications. Unauthorized modifications can void the warranty.

Chrome Hardware

Use a good chrome cleaner and polish on all chrome hardware.

Acrylic Plastic Glass

Acrylic glass scratches easily. Never use a dry cloth or glass cleaning solutions on acrylic. Use a soft cloth and mild soap and water for routine cleaning. Solvents and products containing ammonia can permanently damage acrylic plastic glass.

Fine scratches can be removed with a fine automotive clear coat polishing compound. A coat of automotive or boat wax is beneficial to protect the surface.

Do not use the following on acrylic glass:

Abrasive cleaners	Acetone
Solvents	Alcohol
Glass cleaners	Cleaners containing ammonia

11.2 Upholstery, Canvas and Enclosures

Vinyl Upholstery

The vinyl upholstery used on the exterior seats and bolsters, and for the headliner in the cabin should be cleaned periodically with soap and water. Any stain, spill or soiling should be cleaned up promptly to prevent the possibility of permanent staining. When cleaning, always rub gently. Avoid using products containing ammonia, powdered abrasive cleaners, steel wool, strong solvents, acetone and lacquer solvents or other harsh chemicals as they can cause permanent damage or shorten the life of vinyl. Never use steam heat, heat guns or hair dryers on vinyl.

Stronger cleaners, detergents and solvents may be effective in stain removal, but can cause either immediate damage or slow deterioration. Lotions, sun tan oil, waxes and polishes, etc., contain oils and dyes that can cause stiffening and staining of vinyls.

The following are typical stains and cleaning tips for vinyl:

- Dry soil, dust and dirt - Remove with a soft cloth.
- Dried on dirt - Wash with a soft cloth dampened with water.
- Variations in surface gloss - Wipe with a water dampened soft cloth and allow to air dry.

- Stubborn dirt - Wash with a soft cloth dampened with Ivory Flakes® and water. Rinse with clean water.
- Stubborn spots and stains - Spray with Tannery Car Care Cleaner® and rub with a soft cloth. Rinse with clean water.
- Liquid spills - Wipe immediately with a clean absorbent cloth. Rinse with clean water.
- Food grease and oily stains - Spray immediately using Tannery Car Care Cleaner®, wiping with a soft cloth. Take care not to extend the area of contamination beyond its original boundary. Rinse with clean water.

Canvas and Side Curtains

Acrylic (Sunbrella) canvas should be cleaned periodically by using a mild soap and water. Scrub lightly and rinse thoroughly to remove the soap. Do not use detergents. The top or accessories should never be folded or stored wet.

After several years, the acrylic canvas may lose some of its ability to shed water. If this occurs, wash the fabric and treat it with a commercially available water proofing designed for this purpose.

Note: Some leakage at the seams is normal and unavoidable with acrylic enclosures.

Curtains and clear connectors can be cleaned with mild soap and water. They should not be allowed to become badly soiled. Dirt, oil, mildew, and cleaning agents containing ammonia, will shorten the life of the vinyl that is used for clear curtains. After cleaning the curtains and allowing them to dry, apply a non-lemon furniture polish or an acrylic glass and clear plastic protector to extend the life of the curtains.

Vinyl curtains should be stored either rolled or flat, without folds or creases. Folding the curtains will make permanent creases that could cause the vinyl to crack.

Note: Do not use any polish containing lemon scents or lemon. The lemon juice will attack the vinyl and shorten its life.

Snaps should be lubricated periodically with petroleum jelly or silicone grease. Zippers should be lubricated with silicone spray or paraffin or a product designed to lubricate zippers in marine canvas.

Enclosures must be removed when trailering. Canvas enclosures are not designed to withstand the extreme wind pressure encountered while trailering and will be

damaged. Always remove and properly store the enclosure before trailering your boat.

Do not operate engines, fuel consuming heaters or burners with the canvas enclosures closed. The cockpit must be open for legal ventilation and to prevent the possible accumulation of carbon monoxide fumes, which could be lethal.

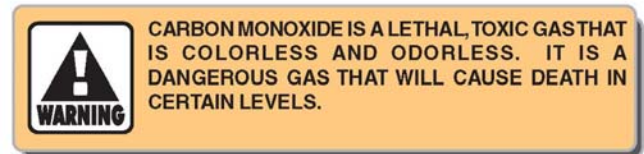

11.3 Bilge and Engine Compartment

To keep the bilge clean and fresh, use a commercial bilge cleaner regularly. Follow the directions carefully. The engines and engine room should be kept clean and free of oil accumulation and debris. All exposed pumps and metal components, including the engines and drive gear, should be sprayed periodically with a protector to reduce the corrosive effects of the high humidity always present in these areas.

Periodically check the bilge pumps for proper operation and clean debris from the strainers and float switches. Inspect all hoses, clamps and thru-hulls for leaks and tightness on a regular basis and operate all thru-hull valves at least once a month to keep them operating properly.

Test the bilge pump automatic switches regularly by rotating the knob on the side of each switch until the pump activates.

11.4 Engine and Fuel

Proper engine maintenance is essential for the proper performance and reliability of your outboard engine. Maintenance schedules and procedures are outlined in your engine owner's manual. They should be followed exactly.

If the boat is used in saltwater, flush the cooling system after each use. To flush the systems when the boat is out of the water, follow the procedure outlined in your engine owner's manual.

The age of gasoline can affect engine performance. Chemical changes occur as the gasoline ages that can cause deposits and vanish in the fuel system as well as reduce the octane rating of the fuel. Severely degraded fuel can damage the engine and boat fuel tank and lines. Therefore, if your boat is not being run enough to require at least one full tank of fresh fuel a month, a fuel stabilizer should be added to the gasoline to protect the fuel from degradation. Your dealer or the engine

manufacturer can provide additional information on fuel degradation and fuel stabilizers recommended for your engine.

Avoid using fuels with alcohol additives. Gasoline that is an alcohol blend will absorb moisture from the air which can reach such concentrations that "phase separation" can occur whereby the water and alcohol mixture becomes heavy enough to settle out of the gasoline to the bottom of the tank. Since the fuel pick up tube is very near the bottom of each tank, phase separation can cause the engine to run very poorly or not at all. This condition is more severe with methyl alcohol and will worsen as the alcohol content increases. Water or a jelly like substance in the fuel filters are an indication of possible phase separation from the use of alcohol blended fuels.

11.5 Drainage System

It is essential that the following items be done periodically to maintain proper drainage of your boat:

- Clean the cockpit drains with a hose to remove debris that can block water drainage.

- Clean the hard top leg drain holes. This is especially important just before winter lay-up.
- Frequently test the automatic bilge pump switches for proper operation. This is accomplished by lifting the float switch until the pump is activated. You can also use a garden hose to flood the bilge until the water level is high enough to activate the pump.
- Flush all gravity drains with freshwater to keep them clean and free flowing.
- Operate the thru-hull valves once a month and service as required.

Note: All drains and pumps must be properly winterized before winter lay-up.

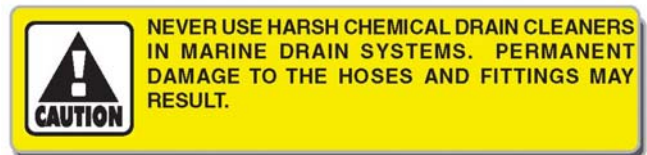

Chapter 12:

SEASONAL MAINTENANCE

12.1 Lay-up and Storage

Before Hauling:

- Pump out the head and holding tank. Flush the holding tank using clean water and a deodorizer. Pump out the cleaning solution.
- The fuel tank should be left nearly full to reduce condensation that can accumulate in the fuel tank. Allow enough room in the tank for the fuel to expand without leaking out the vents.

Bacteria, commonly called algae, can grow in the accumulated water in diesel fuel tanks. This condition is most prevalent in warm climates. Periods of storage or limited use allow the bacteria to accumulate, making the situation worse. Adding a high quality diesel fuel conditioner containing a biocide may be required to control bacteria in your boating area.

- The age of fuel can affect engine performance. Chemical changes occur as the fuel ages that can cause deposits and reduce the octane rating of the fuel. Severely degraded fuel can damage the engine and boat fuel tank and lines. Therefore, if your boat is not being run enough to require at least one full tank of fresh fuel a month, a fuel additive should be added to protect it from degradation. Your dealer or the engine manufacturer can provide additional information on fuel degradation and fuel stabilizers recommended for your engines. Operate the boat for at least 15 minutes after adding the additive to allow the treated fuel to reach the engine.

Your dealer or the engine manufacturer can provide additional information on fuel degradation and fuel additives recommended for your engine. For more recommendations for your specific area, check with your dealer.

- Drain water from the fresh water system.
- Consult the engine owner's manual for detailed information on preparing the engines for storage.

Lifting

It is essential that care be used when lifting your boat. Make sure the spreader bar at each sling is at least as long as the distance across the widest point of the boat that the sling will surround.

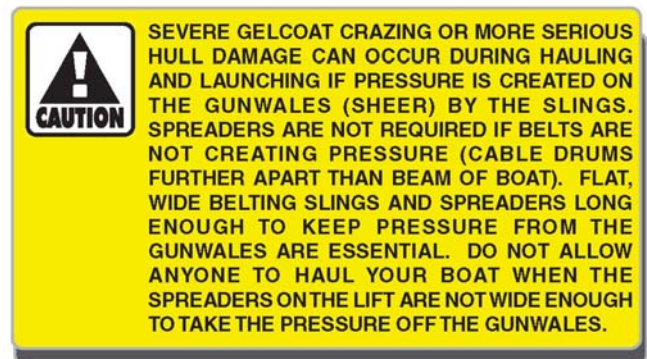
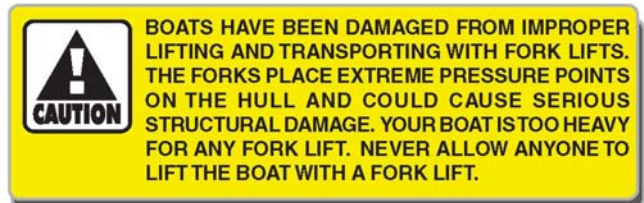

Supporting the Boat for Storage

A trailer, elevating lift, or a well-made cradle is the best support for your boat during storage.

When supporting the boat on a trailer for a long period:

- Make sure the trailer is on level surface and the bow is high enough so that water will drain from the bilge and cockpit.
- The trailer must properly support the hull. The bunks and rollers should match the bottom of the hull and should not be putting pressure on the lifting strakes.
- Make sure the engine(s) are in the down position.
- Make sure the hitch is properly supported.
- Check the tires once each season. Add enough air for the correct amount of inflation for the tires.

Note: Read the owner's manual for the trailer for the correct amount of inflation for the tires.

When storing the boat on a lift or cradle:

- The cradle must be specifically for boat storage.
- Make sure the cradle or lift is well supported with the bow high enough to provide proper drainage of the bilge and cockpit.
- Make sure the engine(s) is in the down position.
- The cradle or lift must be in the proper fore and aft position to properly support the hull. When the cradle or lift is in the correct location, the bunks should match the bottom of hull and should not be putting pressure on the lifting strakes.

When supporting the boat with blocking:

- Make sure the boat is blocked on a level surface and the bow is high enough so that water will drain from the bilge and cockpit.
- Make sure the keel is supported with large, solid wood blocks in at least three points. The keel should be blocked high enough to allow the engines to be tilted to the down position.
- Use at least three heavy duty jacks on each side of the hull and make sure the boat is level from side to side. The jacks must be on a solid surface like packed gravel, concrete or pavement. All of the supports must be set up properly to prevent the boat from shifting while it is in storage.

When storing the boat on a cradle:

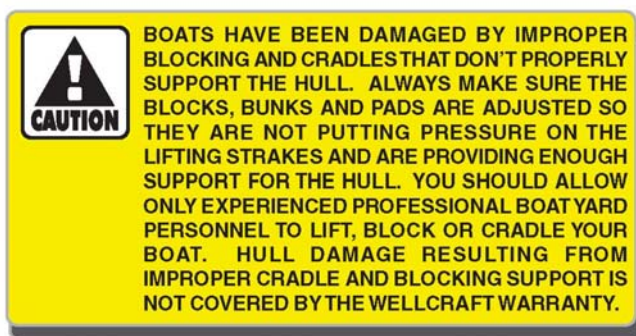

Preparing The Boat For Storage

- Remove the bilge drain plug in the transom.
- Thoroughly wash the fiberglass exterior, especially the antifouling portion of the bottom. Remove as much marine growth as possible. Lightly wax the exterior fiberglass components.

- Remove all oxidation from the exterior hardware, and apply a light film of moisture displacing lubricant.
- Remove propellers and grease the propeller shafts using light waterproof grease.
- Remove the batteries and store in a cool place. Clean using clear, clean water. Be sure the batteries have sufficient water and clean terminals. Keep the batteries charged and safe from freezing throughout the storage period.

Note: Refer to the Electrical System chapter, for information on the maintenance of the AC and DC electrical systems.

- Coat all faucets and exposed electrical components in the cabin and cockpit with a protecting oil.
- Clean out, totally drain and completely dry the fishboxes, sinks and baitwells.
- Thoroughly clean the interior of the head compartment.
- Remove cushions, as many locker doors as possible. Leaving as many of these areas open as possible will improve the boat's ventilation during the storage period.

Note: It is recommended that mildew preventer be hung in the boat's head compartment before it is closed for storage.

- Clean the exterior upholstery with a good vinyl cleaner and dry thoroughly. Spray the weather covers and boat upholstery with a spray disinfectant. Enclosed areas such as the fishboxes, shower basin, storage locker areas, etc. also should be sprayed with this disinfectant.

12.2 Winterizing Freshwater System (Option)

The entire freshwater system must be completely drained. Disconnect all hoses, check valves, etc. and blow all the water from the system. Make sure the freshwater tank is completely drained. Use only very low pressure when doing this to prevent possible system damage. Because of the check valve mechanism built in the pump, blowing the lines will not remove the water from the freshwater pump. Remove the inlet and outlet hoses on the pump. Turn the pump on allow it to pump out any remaining water...about a cupful. A recommended alternative to the above-mentioned procedure is the use of commercially available non toxic, freshwater system antifreeze. After draining the potable water tank and lines, pour the antifreeze mixture into the freshwater tank, prime and operate the pump until the mixture flows from all freshwater faucets. Be sure to

open all water faucets, including the freshwater shower in the cockpit. Make sure antifreeze has flowed through all of the freshwater drains.

Raw Water System

Completely drain the raw water systems. Disconnect all hoses and blow the water from the system. Use only very low air pressure when doing this to prevent possible system damage. Because of the check valve mechanism built in the raw water washdown and livewell pumps, blowing the lines will not remove the water from that raw water pump. Remove the outlet hose on the pump. Turn the pump on and allow it to pump out any remaining water...about a cupful. A recommended alternative to the above-mentioned procedure is the use of commercially available non toxic, potable water system antifreeze. If potable water antifreeze is used, pour the mixture into a pail and put the raw water intake lines into the solution. Run the pumps one at a time until the antifreeze solution is visible at all raw water faucets, discharge fittings and drains. Be sure antifreeze has flowed through all of the raw water drains.

Outboard Engines

The engine(s) should be flushed with freshwater for at least 15 minutes prior to winter storage. This will remove salt, sand and other contaminants that can damage the engine. It is also important to "Fog" the cylinders, change the gear oil, fill the oil tanks (2-cycle engines) or change the oil in 4-cycle engines, coat the engine with a protectant, wax the exterior and properly store and charge the battery. You should refer to the engine owner's manual or contact your dealer for specific instructions on winterizing your engines.

Marine Toilet

The marine toilet must be properly winterized by following the manufacturer's winterizing instructions in the marine toilet owner's manual. Drain the intake and discharge hoses completely using low air pressure if necessary. The head holding tank and overboard discharge pump must be pumped dry and three gallons of potable water antifreeze poured into the tank through the deck waste pump out fitting. After the antifreeze has been added to the holding tank, open the overboard discharge valve and activate the discharge pump until the antifreeze solution is visible at the discharge thru-hull.

Note: Make sure you follow the marine toilet manufacturer's winterizing instructions exactly.

Bilge

Coat all metal components, wire busses, and connector plugs in the bilge with a protecting oil. It is also important to protect all strainers, seacocks and steering

components. The bilge pumps and bilge pump lines must be completely free of water and dried out when the boat is laid up for the winter in climates where freezing occurs. Compartments in the bilge that will not drain completely should be pumped out and then sponged until completely free of water. Dry the hull bilge and self-bailing cockpit troughs. Water freezing in these areas could cause damage.

Seacocks

Most seacocks are winterized when the systems they serve are winterized. Check to make sure each seacock has been winterized and that the valve is open to allow the water to drain out of the valve. Water freezing in seacocks will damage the valves.

Hardtop

It is imperative that all drain holes in the legs are open and that the legs are completely free of water. Remove the enclosure and thoroughly clean and store in a safe, dry place. Remove all electronics. Coat all wire connectors and bus bars in the helm compartment with a protecting oil.

Clean the aluminum frame with soap and water and dry thoroughly. Apply an aluminum metal protectant to the entire frame to reduce corrosion and pitting.

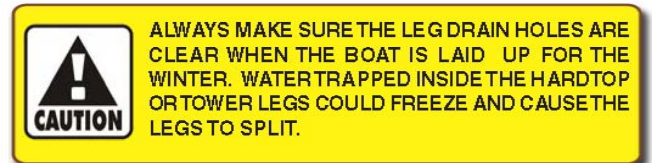

Special Notes Prior To Winter Storage

If the boat will be in outside storage, properly support a storage cover and secure it over the boat. It is best to have a frame built over the boat to support the canvas. It should be a few inches wider than the boat so the canvas will clear the rails and allow passage of air. If this cover is fastened too tightly there will be inadequate ventilation and this can lead to mildew, moisture accumulation, etc. It is essential to fasten the canvas down securely so that the wind cannot remove it or cause chafing of the hull superstructure. Do not store the boat in a damp storage enclosure. Excessive dampness can cause electrical problems, corrosion, and excessive mildew.

Whenever possible, do not use the enclosure curtains in place of the winter storage cover. The life of these curtains may be significantly shortened if exposed to harsh weather elements for long periods.

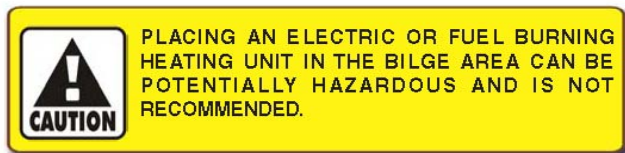

Proper storage is very important to prevent serious damage to the boat. If the boat is to be stored indoors, make sure the building has enough ventilation. It is very important that there is enough ventilation both inside the boat and around the boat.

Note: If the boat is to be stored indoors or outdoors, open all drawers, clothes lockers, cabinets, and doors a little. If possible, remove the upholstery, clothing, and rugs. Then hang a commercially available mildew protector in the head compartment.

12.3 Recommissioning

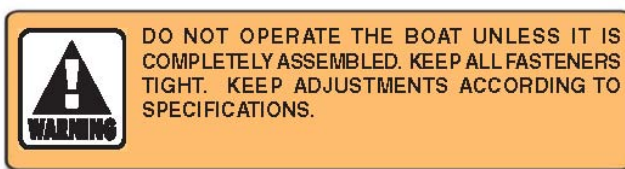

Note: It is important and recommended that the fitting out procedure for the marine gear be done by a qualified marine technician. Read the engine owner's manual for the recommended procedure.



Reactivating The Boat After Storage:

- Apply a fresh coat of bottom paint on the hull.
- Inspect all thru-hull fittings.
- Inspect the sacrificial anodes and install new anodes if required.
- Install the propellers.
- Install the drain plug in the hull.
- Charge and install the batteries.
- Check the engines for damage and follow the manufacturer's instructions for recommissioning.

- Check the engine mounting bolts for the engines and bracket to make sure they are tight.
- Perform all routine maintenance.
- Check all hose clamps and make sure they are tight and not corroded.
- Pump the antifreeze from the head, fresh and raw water systems and flush several times with fresh water.
- Check and lubricate the steering system.
- Clean and wash the boat.
- Install all upholstery, cushions and canvas.

After Launching:

- Carefully check the engines and all water systems and the engine bolts for leaks and proper operation.
- Check the bilge pump manual and automatic switches.
- Prime the fuel system and start the engines. When each engine starts, check the cooling system port below the engine cowling for a strong stream of water. This ensures that the cooling pump is operating.
- Carefully monitor the gauges and check for leakage and abnormal noises.
- Operate the boat at slow speeds until the engine temperature stabilizes and all systems are operating normally.

Appendix A:

SCHEMATICS
210 COASTAL
HELM SWITCH PANEL

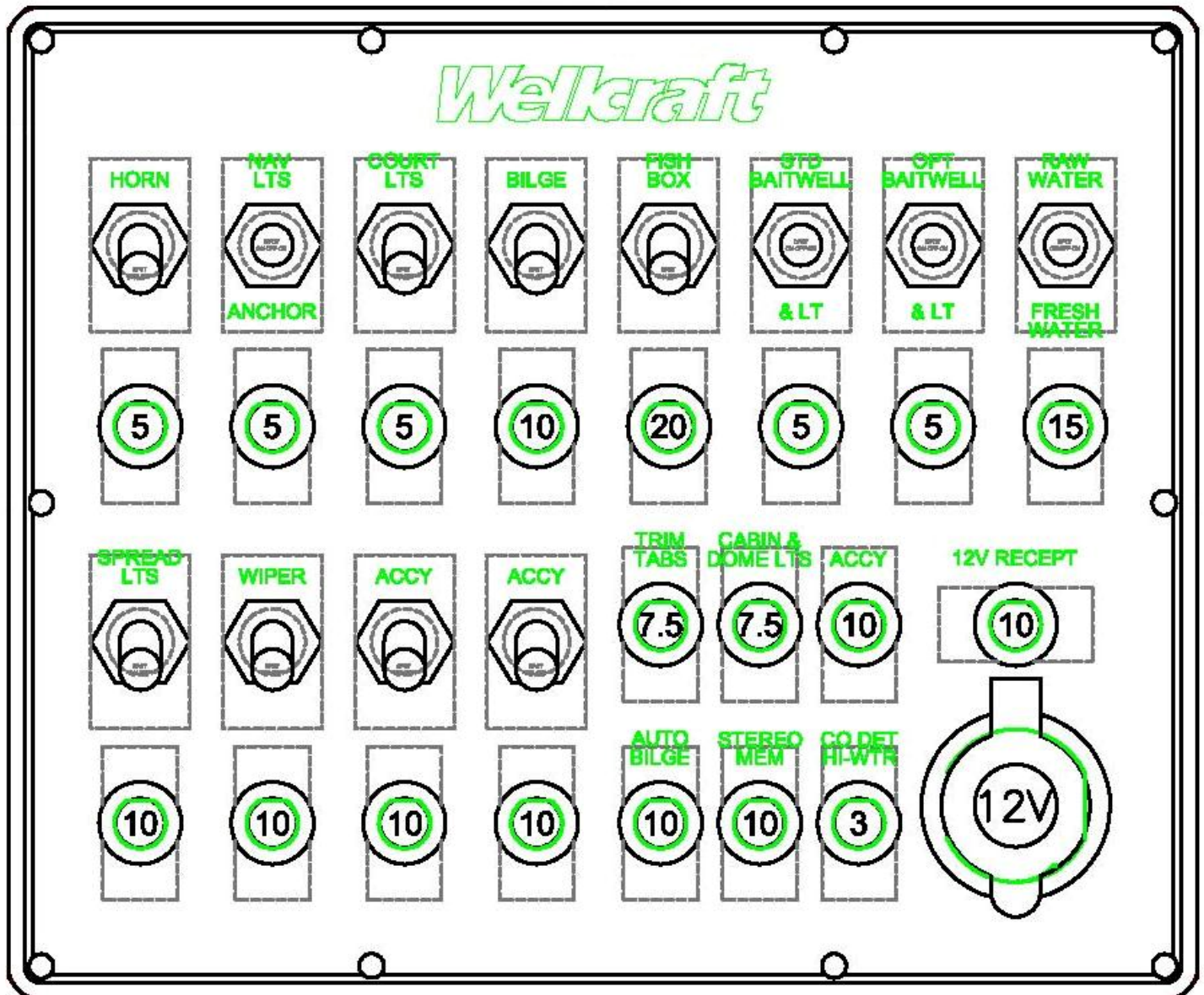

Appendix A:

SCHEMATICS

210 COASTAL STEREO HARNESS

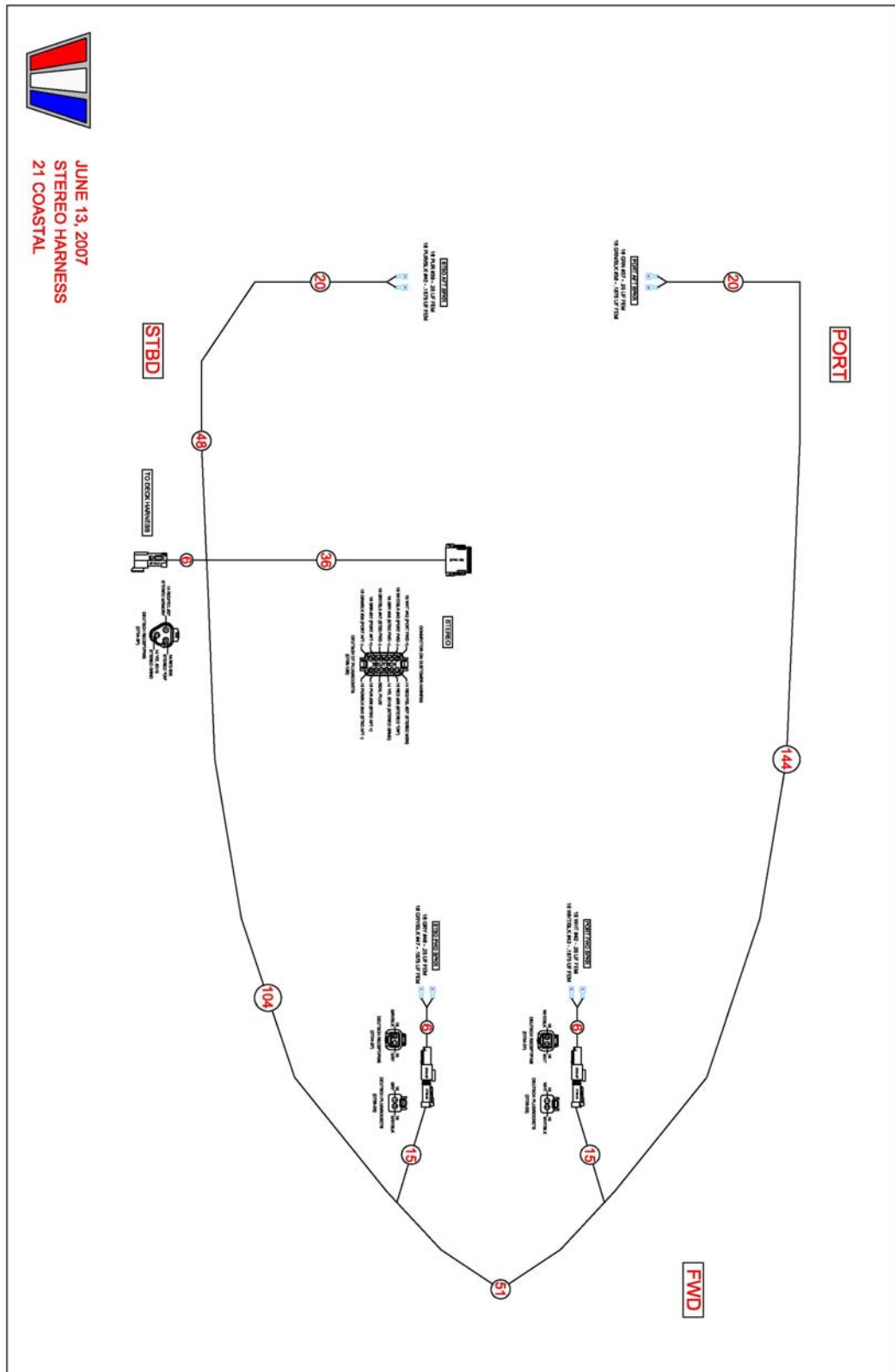

WIRING COLOR CODES

1			
10	Brn/Blu	Pump, Livewell	Livewell
100	Green	Grounds	Seacock Bond/Garbor Drain Bond
101			
102			
103	Yel/Wht	Generator, Exhaust High Temp	Exhaust High Temp
104			
105	Coax	TV System, A/B Switch to Fwd TV	A/B Switch to Fwd TV
106	Coax	TV System, A/B Switch to Aft TV	A/B Switch to Aft TV
107			
108			
109	Blu/Wht	Lights, T-Top Overhead	T-Top Overhead
11	Brn/Yel	Pump, Fishbox	Fishbox
110	Pur	Generator, Run Light	Run Light
111	Yel	Generator, Remote Start/Stop Ground	Remote Start/Stop Ground
112	Red	Generator, Remote Start	Remote Start
113	Red	Generator, Remote Stop	Remote Stop
114	Blk or Grn	Electric Tab Up	Lenco / K-Plane Tab
115	Wht or Blu	Electric Tab Down	Lenco / K-Plane Tab
116	Blu	Trim, Tabs	BENNET UP
117	Yel	Trim, Tabs	BENNET DOWN
118	Red	Trim, Tabs	BENNET PORT
119	Grn	Trim, Tabs	BENNET STBD
12	Red	Batt to Helm	Constant Hot
120			
121	Wht	Water Tank	Sender
122	Red	Battery Charger, Port Battery	Port Battery
123	Red	Battery Charger, Stbd/House Battery	Stbd/House Battery
124	Red	Battery Charger, Gen Battery	Gen Battery
125			
126	Tan	Alarm, Port Eng Exhaust Temp	Port Eng Exhaust Temp
127	Tan/Orn	Alarm, Stbd Eng Exhaust Temp	Stbd Eng Exhaust Temp
128			
129			
13	Lt Grn/Wht	Trim, Engine - Down	Down
130	22/4	Telephone	
131	Blu	Hatch, Fwd Storage	Fwd Storage
132	Yel	Hatch, Fwd Storage	Fwd Storage
133	Grn	Hatch, Fwd Storage	Fwd Storage
134	Orn	Speaker (+), Cockpit Subwoofer	Cockpit Subwoofer
135	Orn/Blk	Speaker (-), Cockpit Subwoofer	Cockpit Subwoofer
136	Red	Isolator, Alternator out to Isolator	Alternator out to Isolator
137	Red/Blk	Isolator, To Port Battery	To Port Battery
138	Red/Yel	Isolator, To Stbd/House Battery	To Stbd/House Battery
139	Tan	Speaker (+), Port Fwd (Overhead)	Port Fwd (Overhead)
139	Tan	Speaker, Port FWD +, Overhead	
14	Lt Blu/Wht	Trim, Engine - Up	Up
140	Tan/Blk	Speaker (-), Port Fwd (Overhead)	Port Fwd (Overhead)
140	Tan/Blk	Speaker, Port FWD -, Overhead	
141	Pnk	Speaker (+), Stbd Fwd (Overhead)	Stbd Fwd (Overhead)

141	Pnk	Speaker, Stbd FWD +, Overhead	
142	Pnk/Blk	Speaker (-), Stbd Fwd (Overhead)	Stbd Fwd (Overhead)
142	Pnk/Blk	Speaker, Stbd FWD - , Overhead	
143			
144			
156	Blu	Lights, Underwater	Underwater Lights
156	Blu	Lights, Underwater	Underwater Lights
146	Red, Blu, Grn	Pump, Power Pole	Power & Controls
146	Red, Blu, Grn	Pump, Power Pole	Power & Controls
147	Red, Blu, Grn	Pump, Jackplate	Power & Controls
147	Red, Blu, Grn	Pump, Jackplate	Power & Controls
148			
149			
15	Pur/Wht	Trim, Engine - Pwr Feed	Power Feed
150			
16	Brn	Pump, Aft Bilge manual	Aft Bilge Manual
17	Brn/yel	Blower, Engine Room	Engine Room
18	Gry	Lights, Bow navigation	Bow Navigation
19	Gry/Blu	Lights, Stern/Anchor	Stern/Anchor
2	Blu	Lights, Gauges	Gauges
20	Red	Electronics	Power Feed
21	Red	Helm	Power Feed
22	Yel	Grounds	Main
23	Brn/Red	Pump, Aft Bilge Auto	Aft Bilge Auto
24	Red	Exhaust	Corsa
25	Brn/Red	Pump, Fwd Bilge Auto	Fwd Bilge Auto
26	Red	Stereo Switched Power Feed	Switched Power Feed
27	Red/Yel	Stereo Memory	Memory
28	Tan/Blk	Extinguisher	Halon System
29	DK Grn	Bonds	Fuel System
3	Pur	Ignition	
30	DK Blu/Red	Lights, Entry	Entry Lights
31	DK Blu	Lights, Dinette	Dinette lights
32	Red/Pur	Trim, Engine - Trailer Power	Trailer Power
33	Orn/Red	Depth Sounder	Power Feed
34	Red	Mercathode	Power Feed
35	Tan/Yel	Alarm, Port Water Temp	Port Water Temp
36	Tan/Blk	Alarm, Stbd Water Temp	Stbd Water Temp
37	Grn	Speaker (+), Port Aft (Cockpit)	Port Aft (Cockpit)
38	Grn/Blk	Speaker (-), Port Aft (Cockpit)	Port Aft (Cockpit)
39	Pur	Speaker (+), Stbd Aft (Cockpit)	Stbd Aft (Cockpit)
40	Pur/Blk	Speaker (-), Stbd Aft (Cockpit)	Stbd Aft (Cockpit)
41	Dk Blu	Lights, Cabin Overhead	Cabin Overhead
4-1	Orn/Red	Power Seat - Aft	Aft
42	Wht	Speaker (+), Port Fwd (Cabin)	Port Fwd (Cabin)
4-2	Red	Power Seat - Feed	Feed
43	Wht/Blk	Speaker (-), Port Fwd (Cabin)	Port Fwd (Cabin)
4-3	Red/Wht	Power Seat - Down	Down
44	Orn	Wiper, Stbd Run	Stbd Run
4-4	Red/Yel	Power Seat - Fwd	Forward
45	Orn/Wht	Wiper, Washer	Washer
4-5	Yel/Red	Power Seat - Up	Up

46	Gry	Speaker (+), Stbd Fwd (Cabin)	Stbd Fwd (Cabin)
47	Gry/Blk	Speaker (-), Stbd Fwd (Cabin)	Stbd Fwd (Cabin)
48	Blu/Wht	Lights, Livewell	Livewell
49	Blu/Red	Lights, Courtesy	Courtesy
50	Yel/Blk	Horn	
51	Red	Receptacle, 12 VDC	12 VDC Outlets
5-1	Red/Wht	Hatch, Engine - Up	Up
52	Blu	Lights, Step	Step
5-2	Yel/Blk	Hatch, Engine - Down	Down
53	Blu/Red	Wiper Park	Park Circuit
54	Pnk/Blk	Engine	Cutoff Circuit
55	Brn/Blu	Pump, Fresh Water	Fresh Water
56	Brn/Blk	Pump, Shower Sump	Shower Sump
57	Blu	Lights, Docking	Docking
58	Lt Blu	Alarm, Port Oil Pressure	Port Oil Pressure
59	Lt Blu/Wht	Alarm, Stbd Oil Pressure	Stbd Oil Pressure
6	Blu/Wht	Stereo, Remote Switching	Remote Switching
60	Red	Trim, Tabs -Power Feed	Power Feed
61	Red	Ships Service DC	AC/DC Panel
62	Brn/Red	Pump, High Water Auto	High Water Auto
63	Brn	Pump, Aft Cabin Bilge Manual	Aft Cabin Bilge Manual
64	Brn/Red	Pump, Aft Cabin Bilge Auto	Aft Cabin Bilge Auto
65	Red	Helm Constant Hot	First Mate
66	Red	TV Antenna	Power Feed
67	Gry/Wht	Lights, Mast Anchor	Mast Anchor
68	Gry	Lights, Mast Nav	Mast Nav
69	Orn/Blk	CO Detector	Power Feed
7	Pnk	Fuel Sender	(Tag Red for Port, Green for Stbd)
70	Red	Head Systems	Accessory Panel Power Feed
71	Orn	Wiper, Center Run	Center Run
72	Brn	Pump, High Water Manual	High Water Manual
73	Orn/Blu	Wiper, Port Run	Port Run
74	Brn/Blk	Head Systems, Vacu-Flush	Vacu-Flush Power Feed
75	Brn/Yel	Blower, Head Vent	Head Vent
76	Brn/Yel	Blower, Generator	Generator
77	Brn/Blk	Head Systems - Macerator	Macerator
78	Red	Refrigerator, Cabin	Cabin
79	Red	Refrigerator, Cockpit	Cockpit
8	Yel/Red	Neutral Start	
80	Brn	Pump, Fwd Bilge Manual	Fwd Bilge Manual
81	Red	Holding Tank, Indicator Power Feed	Indicator Power Feed
81-1	Lt Grn	Holding Tank, Indicator Empty	Indicator Empty
81-2	Lt Blu	Holding Tank, Indicator 1/2	Indicator 1/2
81-3	Brn	Holding Tank, Indicator Full	Indicator Full
82	Blu	Lights, Head	Head
83	Brn/Red	Pump, Mid Bilge Auto	Mid Bilge Auto
84	Brn	Pump, Mid Bilge Manual	Mid Bilge Manual
85	Red	Battery Parallel	Solenoid Feed
86	Brn/Blu	Pump, Raw Water	Raw Water
87	Blu	Lights, Galley	Galley
88	Blu	Lights, Spreader	Spreader
89	Coax	TV System, Antenna to Switch	Antenna to Switch

9	Red	Spotlight	Power Feed
90	Coax	TV System, Cable to Switch	Cable to Switch
91	Blu	Lights, Engine Room	Engine Room
92	Red	Windlass, Power Feed	Power Feed
93	Red/Blu	Windlass, Anchor Up	Anchor Up
94	Red/Grn	Windlass, Anchor Down	Anchor Down
95	Blu	Lights, Closet	Closet
96	Blu	Lights, Indirect	Indirect
97	Red	Freezer	Power Feed
98	Blu	Lights, V-Berth	V-Berth
99	Red	Downriggers	Power Feed

All BRANCH wires will be numbered with a "numerical" suffix.

All GROUND wires will be YELLOW. They'll be identified by the circuit number with a "G" suffix.

All models designed after January 2001 will have this new color code and numbering system.

All POWER FEED wires will have an "A" Suffix.

Revised

(Numerical)

WELLCRAFT 2007 Models - Wiring Harness Color Code & Numbering System

Wire #	Color/Stripe	Circuit	Function
--------	--------------	---------	----------

Example: Cabin Lights: wire # 41 Dk Blue (12V), wire # 41G Yellow (ground)

Example: Cabin Light power feed wire #41A

Example: Cabin Light wire from circuit breaker to first junction will be #41.

From the first junction to the first light will be # 41-1

From the first junction to the second light will be # 41-2

Appendix A:

**SCHEMATICS
210 COASTAL
TRAILER DRAWING**

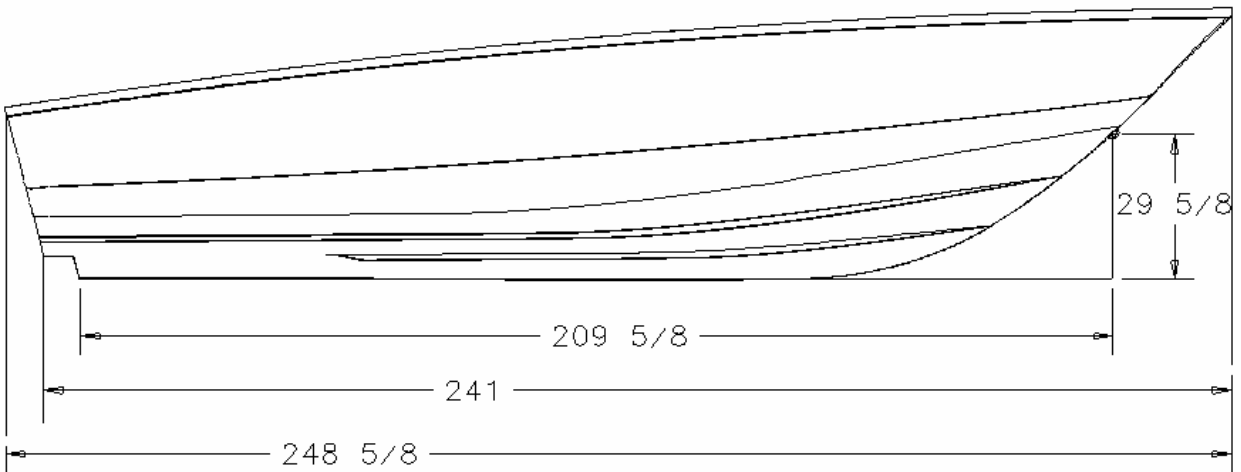

MAX. WEIGHT: 5,000 LBS
DEADRISE 20 DEGREES

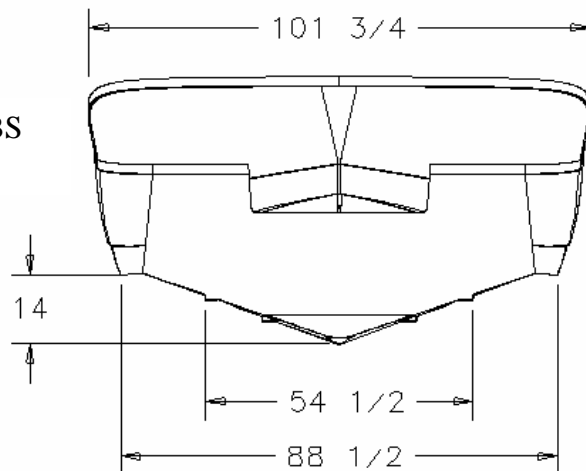

Appendix B:

INSPECTION / SERVICE CHECKLIST

SERVICE	AT LAUNCH AND FIRST OPERATION*	25 HOUR CHECK EACH SEASON*	BI-SEASONALLY OR EVERY 6 MONTHS OR EVERY 100 HOURS*	SEASONALLY OR EVERY 12 MONTHS OR EVERY 200 HOURS*
Engine and Instrumentation				
Engine Maintenance 2 Stroke or 4 Stroke	As Recommended by the Manufacturer			
Check Engine Mounting Bolts		*	*	
Check Propellers			*	
Check All Thru-Hull Fittings				
Test Emergency Shut-Off Switch				
Gauge			*	
Controls Systems				
Throttle and Shift Adjustment				*
Neutral Safety Switch Test				
Cable and Control Lubrication			*	
Steering Systems				
Linkage and Connection Inspection				
Lower Unit Torque Tab Adjustment				
Power Steering Service	As Recommended by the Manufacturer			
Steering Adjustments				
Steering System Lubrication			*	
Electrical Systems				
Inspect Battery Connections				
Check Battery Water				
Battery Cable Inspection				
12 Volt Electrical Equipment Inspection				
12 Volt Wiring and Connection Inspection				
Shore Power Cord and Adapter Inspection				
Polarity Light Operation				
Receptacle and Connection Inspection				
Fuel System				
Inspect for Leaks				
Fuel Sender Inspection				*
Fuel Filter Inspection				
Fuel Tank Inspection				*

* Or as Required



--- Shaded areas indicate the time frame when service/inspection should be conducted.

SERVICE	AT LAUNCH AND FIRST OPERATION*	25 HOUR CHECK EACH SEASON*	BI-SEASONALLY OR EVERY 6 MONTHS OR EVERY 100 HOURS*	SEASONALLY OR EVERY 12 MONTHS OR EVERY 200 HOURS*
Water Systems				
Inspect Fresh & Raw Water Systems				
Fresh Water Tank Inspection				
Drain, Flush, & Treat Fresh Water System				*
Ventilation and Drainage				
Blower Operation				
Auto Bilge Pump Switch Operation				
Bilge Pump Operation and Cleaning				
Check Transom Drain Plug				
Deck Hatch & Porthole Operation				
Interior Equipment				
Head Maintenance	As Recommended by the Manufacturer			
Thru-Hull Fitting Inspection				
Refrigerator Cleaning				*
Clean Coolers & Fish Boxes				
Stove Fuel System				
Stove Maintenance	As Recommended by the Manufacturer			
Microwave Cleaning	As Required			
Exterior Equipment				
Check PFD's for Serviceability and Correct Number	As Required			
Check Charge of Fire Extinguishers	As Required			
Check Compass for Magnetic Deviation				*
Windlass Maintenance	As Recommended by the Manufacturer			
Check Trim Tab Fluid Level			*	
Check Trim Tab System for leakage				
Clean Windshield	As Needed			
Upholstery				
Upholstery Clean				*
Clean Carpet				*
Spray Upholstery with UV Protectant/Conditioner				*
Check Seat Hinges and Mounting Hardware				*

* Or as Required



--- Shaded areas indicate the time frame when service/inspection should be conducted.

SERVICE	AT LAUNCH AND FIRST OPERATION*	25 HOUR CHECK EACH SEASON*	BI-SEASONALLY OR EVERY 6 MONTHS OR EVERY 100 HOURS*	SEASONALLY OR EVERY 12 MONTHS OR EVERY 200 HOURS*
Weather Covers				
Wash Weather Covers				
Spray Weather Covers				
Fiberglass Components and Hull				
Check All Fastenings (securing rails, seats, etc.)				
Clean Fiberglass Thoroughly				
Wax Hull Sides and All Non-Tread Areas				
Inspect Fiberglass Areas for Damage				
Perform Minor Touch-Up Repairs				
Sand Hull and Re-Apply Anti-Fouling Paint				
Woodwork & Composite Maintenance				
Clean Wood Trim	As Needed			
Clean Star Board	As Needed			
Clean Cockpit Tables / Countertop	As Needed			
Clean Plexiglass Components	As Needed			
Trailers				
As Recommended by the Manufacturer				
Wax Trailer			*	
Lubricate Trailer Jack				
Lubricate Trailer Coupler				
Lubricate Trailer Winch				
Brake Operation	Before Every Use			
Brake Inspection			*	
Inspect Hubs/Disc Brakes				
Inspect Bearings & Seals				
Lubricate Bearings				
Springs, Hangers & Suspension Parts				
Wheel Lug Nut		*		
Wheels				
Tire Pressure & Condition	Before Every Use			

* Or as Required

 --- Shaded areas indicate the time frame when service/inspection should be conducted.

Appendix C:

FLOAT PLAN

Wellcraft recommends filling out a float plan each time you use your boat for an offshore day trip or a long cruise. Leave this information with a responsible person ashore, like a close friend or relative that you know well.

1. Name of person reporting and telephone number _____

2. Description of boat.
Type _____ Color _____ Trim _____
Registration No _____ Length _____
Name _____ Make _____ Other Info _____

3. Engine type _____ H.P. _____
No. of Engines _____ Fuel Capacity _____

4. Survival equipment: (Check as appropriate)

<input type="checkbox"/> PFDS	<input type="checkbox"/> Flares	<input type="checkbox"/> Mirror
<input type="checkbox"/> Smoke Signals	<input type="checkbox"/> Flashlight	<input type="checkbox"/> Food
<input type="checkbox"/> Paddles	<input type="checkbox"/> Water	<input type="checkbox"/> Others
<input type="checkbox"/> Anchor	<input type="checkbox"/> Raft or Dinghy	<input type="checkbox"/> EPIRB

5. Radio Yes No Type _____

6. Automobile license _____
Type _____ Trailer License _____
Color _____ and make of auto _____

7. Persons aboard _____
Name _____ Age _____ Address & telephone No. _____

8. Do any of the persons aboard have a medical problem?
 Yes No If yes, what? _____

9. Trip Expectations: Leave at _____
From _____ Going to _____
Expect to return by _____ (time) _____
And no later than _____

10. Any other pertinent info. _____

11. If not returned by _____ (time) _____
Call the COAST GUARD, or (Local authority) _____

12. Telephone Numbers.

Appendix D:

BOAT ACCIDENT REPORT

DEPARTMENT OF TRANSPORTATION U.S. COAST GUARD C.G. 1865 (REV. 1/88)		BOATING ACCIDENT REPORT			FORM APPROVED OMB NO.211-0010	
The operator/owner of a vessel used for recreational purposes is required to file a report in writing whenever an accident results in: loss of life or disappearance from a vessel, or an injury which requires medical treatment beyond first aid; or property damage in excess of \$200 or complete loss of the vessel. Reports in death and injury cases must be submitted within 48 hours. Reports in other cases must be submitted within 10 days. Reports must be submitted to reporting authority in the state where the accident occurred. This form is provided to assist the operator in filing the required written report.						
COMPLETE ALL BLOCKS (indicate those not applicable by "NA")						
NAME AND ADDRESS OF OPERATOR		AGE OF OPERATOR DATE OF BIRTH		OPERATOR'S EXPERIENCE This type of boat Other boat operating Exp. [] Under 20 Hours [] Under 20 Hours [] 20 to 100 Hours [] 20 to 100 Hours [] 100 to 500 Hours [] 100 to 500 Hours [] Over 500 Hours [] Over 500 Hours		
OPERATOR TELEPHONE NUMBER		OWNER TELEPHONE NO.				
NAME AND ADDRESS OF OWNER		RENTED BOAT [] YES [] NO	NUMBER OF PERSONS ON BOARD	FORMAL INSTRUCTION IN BOATING SAFETY [] None [] State [] U.S. Power Squadrons [] USCG Auxiliary [] American Red Cross [] Other (Specify) _____		
VESSEL NO. (this vessel)						
BOAT REGISTER. NO.	BOAT NAME	BOAT MAKE	BOAT MODEL	MFR HULL IDENTIFICATION NO.		
TYPE OF BOAT [] Open Motorboat [] Cabin Motorboat [] Auxiliary Sail [] Sail (only) [] Rowboat [] Canoe [] Other (Specify)	HULL MATERIAL [] Wood [] Aluminum [] Steel [] Fiberglass [] Rubber/vinyl [] Other	ENGINE [] Outboard [] Inboard gasoline [] Inboard diesel [] Inboard-out-	PROPULSION No. of engines _____ Horse Power (total) _____ Type of fuel _____	CONSTRUCTION Length _____ Year built (boat) _____ Has boat had a Safety Examination? [] Outboard [] NO For current year? [] YES [] NO Year _____ Indicate whether [] USCG Auxiliary Courtesy Marine Exam [] State/local examination [] Other		
ACCIDENT DATA						
DATE OF ACCIDENT	TIME am pm	NAME OF BODY OF WATER	LOCATION (Give location precisely)		Lat	Long
STATE	NEAREST CITY OR TOWN		COUNTY			
WEATHER [] Clear [] Rain [] Cloudy []	WATER CONDITIONS [] Calm (waves less than 6") [] Choppy (waves 6" to 2') [] Rough (greater than 6') [] Strong Current		TEMPERATURE (Estimate) Air _____ F° Water _____ F°	WIND [] None [] Light (0 - 6 mph) [] Moderate (7 - 14 mph) [] Strong (15 - 25 mph)	VISIBILITY DAY NIGHT [] Good [] [] Fair [] [] Poor []	
OPERATION AT TIME OF ACCIDENT (Check all applicable) [] Commercial Activity [] Cruising [] Maneuvering [] Approaching Dock [] Leaving Dock [] Water Skiing [] Racing [] Towing [] Other (Specify)	TYPE OF ACCIDENT (Check all applicable) [] Drifting [] At Anchor [] Tied to Dock [] Fueling [] Fishing [] Hunting [] Shin Diving/ Swimming [] Being Towed		Grounding Collision with Capsizing Fixed Object Flooding [] Collision with Sinking Floating Object Fire or explosion (fuel)		WHAT IN YOUR OPINION CONTRIBUTED TO THE ACCIDENT (Check all applicable) [] Weather [] Alcohol use [] Excessive speed [] Drug use [] No Proper Lookout [] Fault of Hull [] Restricted Vision [] Fault of Machinery [] Overloading [] Fault of Equipment [] Improper Loading [] Hunting [] Racing [] Operator Inexperience [] Hazardous Waters [] Operator Inattention [] Other (Specify)	
PERSONAL FLOTATION DEVICES (PFDs)			PROPERTY DAMAGE	FIRE EXTINGUISHERS		
Was the boat adequately equipped with COAST GUARD APPROVED FLOTATION DEVICES? [] Yes [] No Were they accessible? [] Yes [] No Were they serviceable? [] Yes [] No Were they used by survivors? [] Yes [] No What type? [] I, [] II, [] III, [] IV, [] V (specify) _____ Were PFD's properly used? [] Yes [] No Adjusted [] Yes [] No Sized [] Yes [] No			Was the vessel carrying <u>NON</u> approved flotation devices? [] Yes [] No Were they accessible? [] Yes [] No Were they used? [] Yes [] No If Yes, indicate kind.		Estimated amount This boat \$ Other boat \$ Other Property \$	
			DESCRIBE PROPERTY DAMAGE		Were they used? (If yes, list Type(s) and number used.) [] Yes [] No [] NA Types:	
			NAME AND ADDRESS OF OWNER OF DAMAGED PROPERTY			
Include any comments of PFD's under ACCIDENT DESCRIPTION on other side of form						

If more than 3 fatalities and/or injuries, attach additional form(s)

DECEASED

NAME	ADDRESS	DATE OF BIRTH	WAS VICTIM? <input type="checkbox"/> Swimmer <input type="checkbox"/> Non Swimmer	DEATH CAUSED BY <input type="checkbox"/> Drowning <input type="checkbox"/> Other <input type="checkbox"/> DISAPPEARANCE	WAS PFD WORN? <input type="checkbox"/> Yes <input type="checkbox"/> No What Type?
NAME	ADDRESS	DATE OF BIRTH	WAS VICTIM? <input type="checkbox"/> Swimmer <input type="checkbox"/> Non Swimmer	DEATH CAUSED BY <input type="checkbox"/> Drowning <input type="checkbox"/> Other <input type="checkbox"/> DISAPPEARANCE	WAS PFD WORN? <input type="checkbox"/> Yes <input type="checkbox"/> No What Type?
NAME	ADDRESS	DATE OF BIRTH	WAS VICTIM? <input type="checkbox"/> Swimmer <input type="checkbox"/> Non Swimmer	DEATH CAUSED BY <input type="checkbox"/> Drowning <input type="checkbox"/> Other <input type="checkbox"/> DISAPPEARANCE	WAS PFD WORN? <input type="checkbox"/> Yes <input type="checkbox"/> No What Type?

INJURED

NAME	ADDRESS	DATE OF BIRTH	NATURE OF INJURY	MEDICAL TREATMENT
NAME	ADDRESS	DATE OF BIRTH	NATURE OF INJURY	MEDICAL TREATMENT
NAME	ADDRESS	DATE OF BIRTH	NATURE OF INJURY	MEDICAL TREATMENT

ACCIDENT DESCRIPTION

DESCRIBE WHAT HAPPENED (Sequence of events. Include Failure of Equipment. If diagram is needed, attach separately. Continue on additional sheets if necessary. Include any information regarding the involvement of alcohol and/or drugs in causing or contributing to the accident. Include any descriptive information about the use of PFD's.)

VESSEL NO. 2 (if more than 2 vessels, attach additional form (s))

Name of Operator	Address	Boat Number
Telephone Number		Boat Name
Name of Owner	Address	

WITNESSES

Name	Address	Telephone Number
Name	Address	Telephone Number
Name	Address	Telephone Number

WITNESSES

SIGNATURE	Address	Telephone Number
QUALIFICATION (Check One) <input type="checkbox"/> Operator <input type="checkbox"/> Owner <input type="checkbox"/> Investigator <input type="checkbox"/> Other		Date Submitted

(do not use) - **FOR REPORTING AUTHORITY REVIEW** (use agency date stamp)

Causes based on (check one) <input type="checkbox"/> This report <input type="checkbox"/> Investigation and this report <input type="checkbox"/> Investigation <input type="checkbox"/> Could not be determined	Name of Reviewing Office	Date Received
Primary Cause of Accident	Secondary Cause of Accident	Reviewed By

Appendix E:

GLOSSARY OF TERMS

Aft: In, near, or toward the stern of a boat.

Aground: A boat stuck on the bottom.

Amidships: In or toward the part of a boat midway between the bow and stern.

Anchor: A specially shaped heavy metal device designed to dig efficiently into the bottom under a body of water and hold a boat in place.

Anchorage: An area specifically designated by governmental authorities in which boats may anchor.

Ashore: On shore.

Astern: Behind the boat, to move backwards.

Athwartship: At right angles to the center line of the boat.

Barnacles: Small, hard-shelled marine animals which are found in salt water attached to pilings, docks and bottoms of boats.

Beam: The breadth of a boat usually measured at its widest part.

Bearing: The direction of an object from the boat, either relative to the boat's direction or to compass degrees.

Berth: A bunk or a bed on a boat.

Bilge: The bottom of the boat below the flooring.

Bilge Pump: A pump that removes water that collects in the bilge.

Boarding: Entering or climbing into a boat.

Boarding Ladder: Set of steps temporarily fitted over the side of a boat to assist persons coming aboard.

Boat Hook: Short shaft of wood or metal with a hook fitting at one end shaped to aid in extending one's reach from the side of the boat.

Bow: The front end of a boat's hull.

Bow Line: A line that leads forward from the bow of the boat.

Bow Rail: Knee high rails of solid tubing to aid in preventing people from falling overboard.

Bridge: The area from which a boat is steered and controlled.

Bridge Deck: A deck forward and usually above the cockpit deck.

Broach: When the boat is sideways to the seas and in danger of capsizing; a very dangerous situation that should be avoided.

Bulkhead: Vertical partition or wall separating compartments of a boat.

Cabin: Enclosed superstructure above the main deck level.

Capsize: When a boat lays on its side or turns over.

Chock: A deck fitting, usually of metal, with inward curving arms through which mooring or anchor lines are passed so as to lead them in the proper direction both on board and off the boat.

Cleat: A deck fitting, usually of metal with projecting arms used for securing anchor and mooring lines.

Closed Cooling System: A separate supply of fresh water that is used to cool the engine and circulates only within the engine.

Coaming: A vertical piece around the edges of cockpit, hatches, etc. to stop water on deck from running below.

Cockpit: An open space, usually in the aft deck, outside of the cabin.

Companionway: Opening in the deck of a boat to provide access below.

Compartment: The interior of a boat divided off by bulkheads.

Cradle: A framework designed to support a boat as she is hauled out or stored.

Cutlass Bearing: A rubber bearing in the strut that supports the propeller shaft.

Deck: The floor-like platform of a boat that covers the hull.

Displacement: The volume of water displaced by the hull. The displacement weight is the weight of this volume of water.

Draft: The depth of water a boat needs to float.

Dry Rot: A fungus attack on wood areas.

Dry-dock: A dock that can be pumped dry during boat construction or repair.

Electrical Ground: A connection between an electrical connector and the earth.

Engine Beds: Sturdy structural members running fore and aft on which the inboard engines are mounted.

EPIRB: Emergency Position Indicating Radio Beacon. Operates as a part of a worldwide satellite distress system.

Even Keel: When a boat floats properly as designed.

Fathom: A measure of depth. One Fathom = 6 feet.

Fender: A soft object of rubber or plastic used to protect the topsides from scarring and rubbing against a dock or another vessel.

Fend off: To push or hold the boat off from the dock or another boat.

Flying Bridge: A control station above the level of the deck or cabin.

Flukes: The broad portions of an anchor which dig into the ground.

Fore: Applies to the forward portions of a boat near the bow.

Foundering: When a boat fills with water and sinks.

Freeboard: The height from the waterline to the lowest part of the deck.

Galley: The kitchen of a boat.

Grab Rail: Handhold fittings mounted on cabin tops or sides for personal safety when moving around the boat, both on deck and below.

Ground Tackle: A general term including anchors, lines, and other gear used in anchoring.

Grounds: A boat touches the bottom.

Gunwale: The upper edge of a boat's side.

Hand Rail: Rail mounted on the boat, for grabbing with your hand, to steady you while walking about the boat.

Harbor: An anchorage which provides reasonably good protection for a boat, with shelter from wind and sea.

Hatch: An opening in the deck with a door or lid to allow for access down into a compartment of a boat.

Head: A toilet on a boat.

Heat Exchanger: Used to transfer the heat that is picked up by the closed cooling system to the raw cooling water.

Helm: The steering and control area of a boat.

Hull: The part of the boat from the deck down.

Inboard: A boat with the engine mounted within the hull of the boat. Also refers to the center of the boat away from the sides.

Inboard/outboard: Also stern drive or I/O. A boat with an inboard engine attached to an outboard drive unit.

Keel: A plate or timber plate running lengthwise along the center of the bottom of a boat.

Knot: Unit of speed indicating nautical miles per hour. 1 knot = 1 nautical mile per hour (1.15 miles per hour). A nautical mile is equal to one minute of latitude: 6076 feet. Knots times 1.15 equals miles per hour. Miles per hour times .87 equals knots.

Lay-up: To decommission a boat for the winter (usually in northern climates).

Leeward: The direction toward which the wind is blowing.

Length On The Waterline (l.w.l.): A length measurement of a boat at the waterline from the stern to where the hull breaks the water near the bow.

Limber Hole: A passage cut into the lower edges of floors and frames next to the keel to allow bilge water to flow to the lowest point of the hull where it can be pumped overboard.

Line: The term used to describe a rope when it is on a boat.

Lists: A boat that inclines to port or starboard while afloat.

L.O.A.: Boat length overall.

Locker: A closet, chest or box aboard a boat.

Loran: An electronic navigational instrument which monitors the boat's position using signals emitted from pairs of transmitting stations.

Lunch hook: A small light weight anchor typically used instead of the working anchor. Normally used in calm waters with the boat attended.

Midships: The center of the boat.

Marina: A protected facility primarily for recreational small craft.

Marine Ways or Railways: Inclined planes at the water's edge onto which boats are hauled.

Moored: A boat secured with cables, lines or anchors.

Mooring: An anchor permanently embedded in the bottom of a harbor that is used to secure a boat.

Nautical Mile: A unit of measure equal to one minute of latitude. (6076 feet)

Nun Buoy: A red or red-striped buoy of conical shape.

Overboard: A boat designed for an engine to be mounted on the transom. Also a term that refers to objects away from the center line or beyond the hull sides of a boat.

Pad Eye: A deck fitting consisting of a metal eye permanently secured to the boat.

Pier: A structure which projects out from the shoreline.

Pile or Piling: A long column driven into the bottom to which a boat can be tied.

Pitching: The fore and aft rocking motion of a boat as the bow rises and falls.

Pitch: The measure of the angle of a propeller blade. Refers to the theoretical distance the boat travels with each revolution of the propeller.

P.F.D.: Personal Flotation Device.

Port: The left side of the boat when facing the bow.

Porthole (port): The opening in the side of a boat to allow the admittance of light and air.

Propeller: A device having two or more blades that is attached to the engine and used for propelling a boat.

Propeller Shaft: Shaft which runs from the back of the engine gear box, aft, through the stuffing box, shaft log, struts, and onto which the propeller is attached.

Pyrotechnic Distress Signals: Distress signals that resemble the brilliant display of flares or fireworks.

Raw Water Cooled: Refers to an engine cooling system that draws seawater in through a hull fitting or engine drive unit, circulates the water in the engine, and then discharges it overboard.

Reduction Gear: Often combined with the reverse gear so that the propeller turns at a slower rate than the engine.

Reverse Gear: Changes the direction of rotation of the propeller to provide thrust in the opposite direction for stopping the boat or giving it sternway.

Roll: A boat's sideways rotational motion in rough water.

Rope Locker: A locker, usually located in the bow of a boat, used for stowing the anchor line or chain.

Rubrail: Railing (often rubber or hard plastic) that runs along the boat's sheer to protect the hull when coming alongside docks, piers, or other boats.

Rudder: A moveable flat surface that is attached vertically at or near the stern for steering.

Sea anchor: An anchor that does not touch the bottom. Provides drag to hold the bow in the most favorable position in heavy seas.

Scupper: An opening in the hull side or transom of the boat through which water on deck or in the cockpit is drained overboard.

Seacock: Safety valves installed just inside the thru-hull fittings and ahead of the piping or hose running from the fittings.

Shaft Log: Pipe through which the propeller shaft passes.

Sheer: The uppermost edge of the hull.

Sling: A strap which will hold the boat securely while being lifted, lowered, or carried.

Slip: A boat's berth between two pilings or piers.

Sole: The deck of a cockpit or interior cabin.

Spring Line: A line that leads from the bow aft or from the stern forward to prevent the boat from moving ahead or astern.

Starboard: The right side of a boat when facing the bow.

Steerageway: Sufficient speed to keep the boat responding to the rudder or drive unit.

Stem: The vertical portion of the hull at the bow.

Stern: The rear end of a boat.

Stow: To pack away neatly.

Stringer: Longitudinal members fastened inside the hull for additional structural strength.

Strut: Mounted to the hull which supports the propeller shaft in place.

Strut Bearing: See "cutlass bearing."

Stuffing Box: Prevents water from entering at the point where the propeller shaft passes through the shaft log.

Superstructure: Something built above the main deck level.

Swamps: When a boat fills with water from over the side.

Swimming Ladder: Much the same as the boarding ladder except that it extends down into the water.

Taffrail: Rail around the rear of the cockpit.

Thru-hull: A fitting used to pass fluids (usually water) through the hull surface, either above or below the waterline.

Topsides: The side skin of a boat between the waterline or chine and deck.

Transom: A flat stern at right angles to the keel.

Travel Lift: A machine used at boat yards to hoist boats out of and back into the water.

Trim: Refers to the boat's angle or the way it is balanced.

Trough: The area of water between the crests of waves and parallel to them.

Twin-Screw Craft: A boat with two propellers on two separate shafts.

Underway: When a boat moves through the water.

Wake: Disrupted water that a boat leaves astern as a result of its motion.

Wash: The flow of water that results from the action of the propeller or propellers.

Waterline: The plane of a boat where the surface of the water touches the hull when it is afloat on even keel.

Watertight Bulkhead: Bulkheads secured so tightly so as not to let water pass.

Wharf: A structure generally parallel to the shore.

Working Anchor: An anchor carried on a boat for most normal uses. Refers to the anchor used in typical anchoring situations.

Windlass: A winch used to raise and lower the anchor.

Windward: Toward the direction from which the wind is coming.

Yacht Basin: A protected facility primarily for recreational small craft.

Yaw: When a boat runs off her course to either side.

Appendix 7:

TROUBLESHOOTING GUIDE

PROBLEM	CAUSE AND SOLUTION
CONTROL PROBLEMS	
Hydraulic Steering is slow to respond & erratic.	<ul style="list-style-type: none">• Steering system is low on fluid. Fill and bleed system.• Steering system has air in it. Fill and bleed system.• A component in the steering system is binding. Check and adjust or repair binding component.• Engine steering spindle is binding. Grease spindle.
The boat wanders and will not hold a course at cruise speeds.	<ul style="list-style-type: none">• There could be air in the steering system. Fill & bleed the system.• The engine steering tab/anode is corroded or out of adjustment. Replace or adjust steering tab.• Engine steering spindle is binding. Grease spindle.
An engine will not start with the shift control lever in neutral.	<ul style="list-style-type: none">• The control cable is out of adjustment & not activating the neutral safety cut out switch.• The shift control lever is not in the neutral detent. Try moving the shift lever slightly.• There is a loose wire on the neutral safety switch on the control. Inspect wires and repair loose connections.• The starter or ignition switch is bad. Trouble shoot and replace components as necessary.
PERFORMANCE PROBLEMS	
Boat is sluggish and has lost speed & RPM.	<ul style="list-style-type: none">• The boat may be need to have marine growth cleaned from hull and running gear.• Propeller may be damaged & need repair.• Weeds or line around the propeller. Clean propeller.• Boat is overloaded. Reduce load.• Check for excessive water in the bilge. Pump out bilge & find & correct the problem.• The throttle adjustment has changed and the engine is not getting full throttle. Adjust the throttle cable.
The boat vibrates at cruising speeds.	<ul style="list-style-type: none">• Propeller may be damaged & need repair.• The propeller or propeller shaft is bent. Repair or replace damaged components.• The running gear is fouled by marine growth or rope. Clean running gear.• An engine is not trimmed Properly. Trim engine.

TROUBLESHOOTING GUIDE

PROBLEM	CAUSE AND SOLUTION
ENGINE PROBLEMS	
<p>An engine is running too hot.</p>	<ul style="list-style-type: none"> • The engine raw water pick up strainer up is clogged with marine growth. Clean pick up • The engine raw water pump impeller is worn or damaged. Repair the pump. • The engine thermostat is faulty and needs to be replaced.
<p>An engine alternator is not charging properly.</p>	<ul style="list-style-type: none"> • The battery cable is loose or corroded. Clean and tighten battery cables. • The alternator is not charging and must be replaced. • The engine battery isolator in the charging system is not working properly. Replace the isolator. • The battery is defective. Replace the battery.
<p>An engine suddenly will not operate over 2000 RPM.</p>	<ul style="list-style-type: none"> • The engine emergency system has been activated. The on board computer has sensed a problem and has limited the RPM to protect the engine. Find & correct the problem. • The tachometer is bad and needs to be replaced. • The oil tank on a 2-cycle engine is low on oil. Fill the engine oil tank. Refer to the engine owner's manual. • The engine may be overheating. Check engine for overheating condition and correct if necessary.
<p>An engine is losing RPM. The boat is not overloaded and the hull bottom and running gear are clean and in good condition.</p>	<ul style="list-style-type: none"> • The engine may be having a problem with a sticky Anti-siphon valve, located in the fuel line near the fuel tank, that is restricting the fuel flow. Remove & clean or replace the Anti-siphon valve. • The remote gasoline fuel filter could be dirty. Inspect and replace the fuel filter. • The primary fuel filter on the engine may be dirty. Inspect and replace the fuel filter. • The electronic engine control system on the engine is malfunctioning. Repair the engine control system. • The fuel injection system on the engine is malfunctioning. Repair the fuel injection system.

TROUBLESHOOTING GUIDE

PROBLEM	CAUSE AND SOLUTION
ACCESSORY PROBLEMS	
The carbon monoxide detector sounds the alarm when the engines are running.	<ul style="list-style-type: none">• The canvas curtains are up and none of the forward facing vents are open, allowing carbon monoxide to accumulate in the cockpit and cabin. Open the deck hatch, clear connector, and side curtains to provide proper ventilation.• The boat is operating at slow speed and the wind is on the stern pushing CO into the cockpit and cabin. Increase boat speed or change heading if possible.• The carbon monoxide detector is defective and needs to be calibrated by the manufacturer or replaced. Have the boat checked by a professional before condemning the CO monitor.
The freshwater pump runs, but will not pump water.	<ul style="list-style-type: none">• The water tank is empty. Fill the tank.• The in-line strainer for the pump is clogged. Clean the strainer.• The intake hose is damaged and sucking air. Replace or repair the hose.• The pump is defective. Repair or replace the pump.
The washdown pump runs, but the pump will not pump water.	<ul style="list-style-type: none">• The thru-hull valve is not open. Open valve.• The in-line sea strainer for the pump is clogged. Clean the sea strainer.• The intake hose is damaged and sucking air. Replace hose.• The pump is defective. Repair or replace the pump.
The washdown or freshwater pump fails to turn off after all outlets are closed.	<ul style="list-style-type: none">• There is a leak in a pressure line or outlet. Repair the leak.• There is an air leak in the intake line. Repair the air leak.• The pressure switch is defective. Replace the pressure switch.• The voltage to the pump is low. Check for corroded or loose wiring connections or low battery.• The strainer is clogged. Clean strainer.• The pump is defective. Repair or replace the pump.
The livewell pump runs, but does not pump water.	<ul style="list-style-type: none">• The thru-hull valve is not open. Open valve.• The strainer on the intake scoop is clogged preventing the water from getting to the pump. Put the boat in reverse to clean the strainer.• The optional in-line sea strainer for the pump is clogged. Clean strainer.• There is an air lock in the system. Prime the system.

TROUBLESHOOTING GUIDE

PROBLEM	CAUSE AND SOLUTION
ACCESSORY PROBLEMS	
Reduction in water flow from the bilge pump.	<ul style="list-style-type: none"> • Impeller screen plugged with debris. Clean screen at the base of the pump. • The discharge hose is pinched or clogged. Check discharge hose and clean or repair. • Low voltage to the pump. Check the battery and wire connections.
The automatic float switch on the bilge pump raises but does not activate the pump .	<ul style="list-style-type: none"> • The circuit breaker for the automatic switch has tripped. Reset the circuit breaker. • The battery is dead. Charge or replace the battery. • The pump impeller is jammed by debris. Clean pump impeller housing. • The wire connections in the bilge have corroded. Replace connectors and secure above the bilge waterline. • The automatic switch is defective. Replace the switch. • The pump is defective. Replace pump.
The bilge pump will not run when the manual switch is activated.	<ul style="list-style-type: none"> • The circuit breaker supplying the switch has tripped. Reset the circuit breaker. Replace if defective. • The battery switch is off. Turn on the battery switch and bilge pump breaker. • The pump impeller is jammed by debris. Clean pump impeller housing. • The wire connections in the bilge have corroded. Replace connectors and secure above the bilge waterline. • The switch is defective. Replace the switch. • The pump is defective. Replace pump.
Head will not flush.	<ul style="list-style-type: none"> • Electric head breaker is not activated. Turn on breaker. • There is a vacuum leak at the flush valve or the waste hose. Repair the leak. • The holding tank is full and the sensor in the holding tank has deactivated the vacuum pump. Pump out the holding tank.
Head vacuum pump runs more frequently than it should.	<ul style="list-style-type: none"> • There is a slight vacuum leak in the system. Find and repair the leak.
Holding tank will not empty.	<ul style="list-style-type: none"> • Holding tank vent is clogged. Replace charcoal vent filter. • There is a vacuum leak in the hose from the holding tank to the deck pump out fitting. Tight loose fittings or replace damage hoses.

TROUBLESHOOTING GUIDE

PROBLEM	CAUSE AND SOLUTION
ACCESSORY PROBLEMS	

Excessive odor from marine head.

- Back pressure in the holding tank. Pump out holding tank or replace the vent filter.
- Waste is in the discharge hose. Flush enough to move waste to the holding tank, particularly at the end of each day.
- No deodorizer in the holding tank. Add deodorizer to the holding tank each time it is pumped out.
- The waste in the tank is over two weeks old. Pump the holding tank if it has contained waste for two weeks or more.



Wellcraft®

www.wellcraft.com

©2007 Wellcraft Marine Corp. a subsidiary of Genmar Industries, Inc.
1651 Whitfield Avenue, Sarasota, FL 34243

WELLCRAFT is a registered trademark of Genmar Industries, Inc.